

## Repair and Maintenance

PCB guarantees Total Customer Satisfaction through its “Lifetime Warranty Plus” on all Platinum Stock Products sold by PCB and through its limited warranties on all other PCB Stock, Standard and Special products. Due to the sophisticated nature of our sensors and associated instrumentation, **field servicing and repair is not recommended and, if attempted, will void the factory warranty.**

Beyond routine calibration and battery replacements where applicable, our products require no user maintenance. Clean electrical connectors, housings, and mounting surfaces with solutions and techniques that will not harm the material of construction. Observe caution when using liquids near devices that are not hermetically sealed. Such devices should only be wiped with a dampened cloth—never saturated or submerged.

In the event that equipment becomes damaged or ceases to operate, our Application Engineers are here to support your troubleshooting efforts 24 hours a day, 7 days a week. Call or email with model and serial number as well as a brief description of the problem.

## Calibration

Routine calibration of sensors and associated instrumentation is necessary to maintain measurement accuracy. We recommend calibrating on an annual basis, after exposure to any extreme environmental influence, or prior to any critical test.

PCB Piezotronics is an ISO-9001 certified company whose calibration services are accredited by A2LA to ISO/IEC 17025, with full traceability to SI through N.I.S.T. In addition to our standard calibration services, we also offer specialized tests, including: sensitivity at elevated or cryogenic temperatures, phase response, extended high or low frequency response, extended range, leak testing, hydrostatic pressure testing, and others. For more information, contact your local PCB Piezotronics distributor, sales representative, or factory customer service representative.

## Returning Equipment

If factory repair is required, our representatives will provide you with a Return Material Authorization (RMA) number, which we use to reference any information you have already provided and expedite the repair process. This number should be clearly marked on the outside of all returned package(s) and on any packing list(s) accompanying the shipment.

## Contact Information

PCB Piezotronics, Inc.  
3425 Walden Ave.  
Depew, NY14043 USA  
Toll-free: (800) 828-8840  
24-hour SensorLine: (716) 684-0001  
General inquiries: [info@pcb.com](mailto:info@pcb.com)  
Repair inquiries: [rma@pcb.com](mailto:rma@pcb.com)

For a complete list of distributors, global offices and sales representatives, visit our website, [www.pcb.com](http://www.pcb.com).

## Safety Considerations

This product is intended for use by qualified personnel who recognize shock hazards and are familiar with the precautions required to avoid injury. While our equipment is designed with user safety in mind, the protection provided by the equipment may be impaired if equipment is used in a manner not specified by this manual.

Discontinue use and contact our 24-Hour Sensorline if:

- Assistance is needed to safely operate equipment
- Damage is visible or suspected
- Equipment fails or malfunctions

For complete equipment ratings, refer to the enclosed specification sheet for your product.

## Definition of Terms and Symbols

The following symbols may be used in this manual:



### DANGER

Indicates an immediate hazardous situation, which, if not avoided, may result in death or serious injury.

**CAUTION**

Refers to hazards that could damage the instrument.

**NOTE**

Indicates tips, recommendations and important information. The notes simplify processes and contain additional information on particular operating steps.

**The following symbols may be found on the equipment described in this manual:**



This symbol on the unit indicates that high voltage may be present. Use standard safety precautions to avoid personal contact with this voltage.



This symbol on the unit indicates that the user should refer to the operating instructions located in the manual.



This symbol indicates safety, earth ground.



PCB工业监视和测量设备 - 中国RoHS2公布表

PCB Industrial Monitoring and Measuring Equipment - China RoHS 2 Disclosure Table

部件名称	有害物质					
	铅 (Pb)	汞 (Hg)	镉 (Cd)	六价铬 (Cr(VI))	多溴联苯 (PBB)	多溴二苯醚 (PBDE)
住房	0	0	0	0	0	0
PCB板	X	0	0	0	0	0
电气连接器	0	0	0	0	0	0
压电晶体	X	0	0	0	0	0
环氧	0	0	0	0	0	0
铁氟龙	0	0	0	0	0	0
电子	0	0	0	0	0	0
厚膜基板	0	0	X	0	0	0
电线	0	0	0	0	0	0
电缆	X	0	0	0	0	0
塑料	0	0	0	0	0	0
焊接	X	0	0	0	0	0
铜合金/黄铜	X	0	0	0	0	0
本表格依据 SJ/T 11364 的规定编制。						
0：表示该有害物质在该部件所有均质材料中的含量均在 GB/T 26572 规定的限量要求以下。						
X：表示该有害物质至少在该部件的某一均质材料中的含量超出 GB/T 26572 规定的限量要求。						
铅是欧洲RoHS指令2011/65/ EU附件三和附件四目前由于允许的豁免。						

CHINA RoHS COMPLIANCE

Component Name	Hazardous Substances					
	Lead (Pb)	Mercury (Hg)	Cadmium (Cd)	Chromium VI Compounds (Cr(VI))	Polybrominated Biphenyls (PBB)	Polybrominated Diphenyl Ethers (PBDE)
Housing	O	O	O	O	O	O
PCB Board	X	O	O	O	O	O
Electrical Connectors	O	O	O	O	O	O
Piezoelectric Crystals	X	O	O	O	O	O
Epoxy	O	O	O	O	O	O
Teflon	O	O	O	O	O	O
Electronics	O	O	O	O	O	O
Thick Film Substrate	O	O	X	O	O	O
Wires	O	O	O	O	O	O
Cables	X	O	O	O	O	O
Plastic	O	O	O	O	O	O
Solder	X	O	O	O	O	O
Copper Alloy/Brass	X	O	O	O	O	O

This table is prepared in accordance with the provisions of SJ/T 11364.

O: Indicates that said hazardous substance contained in all of the homogeneous materials for this part is below the limit requirement of GB/T 26572.

X: Indicates that said hazardous substance contained in at least one of the homogeneous materials for this part is above the limit requirement of GB/T 26572.

Lead is present due to allowed exemption in Annex III or Annex IV of the European RoHS Directive 2011/65/EU.

## ***Series 421B3X Differential Input Charge Amplifier***

---



### ***Installation and Operating Manual***

---

PCB Piezotronics, Inc.

3425 Walden Avenue, Depew, New York 14043-2495

24-Hour SensorLine<sup>SM</sup> 716 684-0001

Fax 716 684-0987

**Toll Free (USA) 1-800-828-8840**

**E-Mail [info@pcb.com](mailto:info@pcb.com)**



## ***Table of Contents***

---

Introduction .....	3
Description .....	3
Installation .....	3
Wiring and Operation .....	4
Calculation of Gain .....	5
Structural Diagram .....	6
Ordering Information .....	7
Special Considerations .....	7
Use with High Temperature Sensors .....	7
ESD Warning Information .....	8
Warning 1 – ESD sensitivity .....	8
Warning 2 – ESD sensitivity .....	8
Caution 1 – ESD sensitivity .....	8
Caution 2 – ESD sensitivity .....	8
Warranty .....	9
Service .....	9
Return Procedure .....	10
Customer Service .....	10

## Introduction

---

The 421B3X-Series Differential Charge Amplifiers are designed to convert the high-impedance output of a differential, charge-mode piezoelectric sensor to a low-impedance voltage output. These amplifiers may be used with either quartz or ceramic, differential charge-mode piezoelectric sensors.

## Description

---

The amplifier operates on a 22 to 28 VDC power supply. The amplifier employs a high gain amplifier to perform the impedance transformation. The output of the amplifier may be in voltage (mV) or current ( $\mu$ A) and may be scaled in terms of acceleration (g), pressure (psi or mbar) or velocity (in/s or mm/s). The electronic circuitry of the amplifier is incorporated into a molded aluminum enclosure. The amplifier has factory-configurable high-pass and low-pass filters. Furthermore, RFI filters protect the input and output against radio-frequency interference and other electromagnetic influences.

The amplifier is available in three variations, as noted in the table below.

Model	Sensor Type	Input	Output	High Pass Filter (-3dB)	Low Pass Filter (-1dB)
421B30	Pressure Sensor	17 pC/psi	350 mV/psi or $\mu$ A/psi	10 Hz	5 kHz
421B31	Accelerometer	10 pC/g	100 mV/g or $\mu$ A/g	10 Hz	1 kHz
421B3X	Pressure Sensor or Accelerometer	Configurable	Configurable	Configurable	Configurable

## Installation

---

Mount the base of the amplifier to a flat surface near the sensor, with the amplifier's input as close to the sensor as possible. The cable length between the sensor and the amplifier should be as short as possible to reduce the introduction of triboelectric noise into the system.

The 421B3X-Series housing is connected to the common (I-) terminals. Therefore, the amplifier must be mounted so that the housing is isolated from ground.

## Wiring and Operation

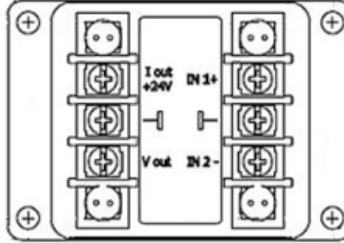

Terminal	Current Output	Voltage Output
I out +24V	Current Output/Power Input	Power Input
⊥	Common	
V out	No Connection	Voltage Output
IN 1+	Sensor Positive Input Signal	
⊥	Sensor Shield	
IN 2-	Sensor Negative Input Signal	

### Input Signal:

- **Differential Piezoelectric Sensor:** Connect the sensor's positive charge output to the positive input (IN1+) and the sensor's negative charge output to negative input (IN2-) using low-noise cable.
- **Non-Differential Piezoelectric Sensor:** Connect the sensor output to the negative input (IN2-) and short the positive input (IN1+) and common (⊥) using low-noise cable. The output signal will be inverted when operating with a non-differential sensor.

### Output Signal:

- **Voltage Output (mV):** The output of the amplifier (V out) should be routed to any readout device using standard coaxial or two-wire cable. The readout device may be an oscilloscope or other monitoring device. The output from the amplifier will be an AC signal proportional to the signal seen by the sensor.
- **Current Output (μA):** A CVLD power supply that provides a voltage within the specified required supply voltage of the amplifier should be used for current mode operation. The output of the CVLD receiver will be a voltage proportional to the V/mA sensitivity of the receiver. A CVLD receiver is the preferred current mode configuration. Alternatively, a current sense resistor can be placed in series on the standard coaxial or two-wire cable running from the output of the amplifier (I out/+24V) to the power supply. The resistor must be less than or equal to 250 Ω. See diagram below of the current mode operation with series resistor. From this resistor, a voltage output can be routed to any readout device. The voltage output across the resistor is proportional to the current output per Ohm's law ( $V = IR$ ). In this configuration the measured voltage will be inverted relative to the current output of the amplifier. For both configurations the readout device may be an oscilloscope or other monitoring device. The output from the amplifier will be an AC signal proportional to the signal seen by the sensor.



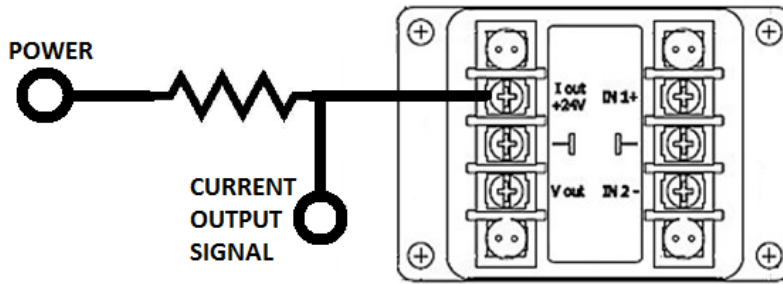

## Calculation of Gain

An amplifier is selected by specifying an input sensitivity and an output sensitivity. As a result, the gain is inherently determined without specifically calling it out. The gain of the amplifier can be calculated using one of the following equations:

		Input Sensitivity Units		
		pC/bar	pC/psi	pC/g
Output Sensitivity Units	mV/mbar	$\frac{(\text{Output} \times 1000)}{\text{Input}}$	$\frac{(\text{Output} \times 68.9475)}{\text{Input}}$	N/A
	mV/psi	$\frac{(\text{Output} \times 14.5037)}{\text{Input}}$	$\frac{\text{Output}}{\text{Input}}$	N/A
	mV/g	N/A	N/A	$\frac{\text{Output}}{\text{Input}}$
	mV/mm/s	N/A	N/A	$\frac{(\text{Output} \times 9806.6) / (2 \times \pi \times f)}{\text{Input}}$
	mV/ <u>ips</u>	N/A	N/A	$\frac{(\text{Output} \times 386.1) / (2 \times \pi \times f)}{\text{Input}}$

Note:

- Current output in  $\mu\text{A}$  always equals voltage output in mV.
- For velocity output models, the gain of the amplifier is frequency (f) dependent.

**Example:** An amplifier ordered with 10 pC/g input sensitivity and a 100 mV/g output sensitivity would have a gain of  $100 \text{ mV/g} / 10 \text{ pC/g} = 10 \text{ mV/pC}$ .

## Structural Diagram

The amplifier structural diagram is shown below:

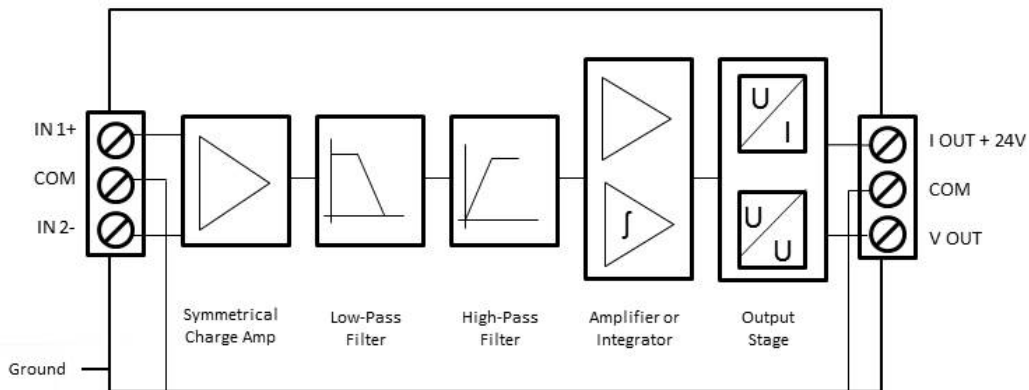

The amplifier converts the charge-based signal from a piezoelectric transducer into a current and voltage signal.

- **Current Output:** The current signal is transmitted to the processing electronics via a 2-wire transmission cable. Two-wire current output is provided by power input/current output (Iout/+24V) and common (I-) terminals. The current output allows transmission over a maximum distance of 3,000 feet. A CVLD power supply as described in the Wiring and Operation section is recommended for this configuration.
- **Voltage Output:** The voltage signal is transmitted to the processing electronics via a 3-wire transmission cable. Three-wire voltage output is provided by power input/current output (Iout/+24V), common (I-) and voltage output (Vout) terminals. The voltage output allows transmission over a maximum distance of 100 feet (without analysis of cable capacitance).

## Ordering Information

To configure a 421B3X-Series amplifier, construct a full model number according to the below scheme.

MODEL	INPUT SENSITIVITY					OUTPUT SENSITIVITY					FILTERS				
	Value				Units	Value				Units	High-Pass		Low-Pass		
	A	A	A	A	B	C	C	C	C	D	E	E	F	F	F
421B3X	0001-1000				G/B/P	0001-5000				G/I/M/P/B	X5-10		002-200		
	0001-0200 pC/g 0001-1000 pC/bar 0001-0100 pC/psi				G=g B=bar P=psi	0010-2000 mV/g 1000-5000 mV/in/s (1-5 in/s full scale) 0010-0100 mV/mm/s 0001-1000 mV/psi 0001-0010 mV/mbar				G=g I=in/s M=mm/s P=psi B=mbar	X5=0.5 Hz 01=1 Hz 02=2 Hz 05=5 Hz 10=10 Hz		002=200 Hz 005=500 Hz 010=1 kHz 020=2 kHz 050=5 kHz 100=10 kHz 200=20 kHz		

Full Model Number for Pre-Configured Models:

- 421B30 for Use with Pressure Sensor = 421B3X-0017-P-0350-P-10-050
- 421B31 for Use with Accelerometer = 421B3X-0010-G-0100-G-10-010

## Special Considerations

High source capacitance may degrade the performance of the amplifier. Source capacitance is the input capacitance to the amplifier defined as transducer capacitance plus cable capacitance. If the source capacitance is increased due to a long length of cable, amplifier noise will increase and frequency response will decrease.

Low frequency response is 10 Hz when used in current output configuration.

## Use with High Temperature Sensors

The amplifier is specifically designed for use with piezoelectric sensors with an operating temperature range of greater than 500 °F (260 °C), which typically have lower insulation resistance values. The amplifier will operate with insulation resistances as low as 50 kOhm.

**Note:** When using the 421B3X series differential charge amplifier with high temperature sensors, the unit may have a longer turn-on time than typical charge amplifiers which are designed for use with sensors with high insulation resistance.

**Caution!** Excessive accumulated charges on the input cables can destroy the field effect transistor (FET) in the amplifier. These charges can be grounded before connection by shorting the center pin on the cable connector plug to its knurled nut with any metallic object.

## ESD Warning Information

---

### **Warning 1 – ESD sensitivity**

---

**The 421B3X Series Differential Charge Amplifier should be opened by PCB factory-qualified personnel only.** This product is intended for use by qualified personnel who recognize shock hazards and are familiar with the safety precautions required to avoid injury.

### **Warning 2 – ESD sensitivity**

---

This equipment is designed with user safety in mind; however, the protection provided by the equipment may be impaired if the equipment is used in a manner not specified by PCB Piezotronics, Inc.

### **Caution 1 – ESD sensitivity**

---

**Cables can kill your equipment.** Although 421 series differential charge amplifiers have protection, they can still be damaged by high level voltage from electrostatic discharge (ESD). Similar to a capacitor, a cable can hold a charge caused by triboelectric transfer, such as that which occurs in the following:

- Laying on and moving across a rug,
- Any movement through air,
- The action of rolling out a cable, and/or
- Contact with a non-grounded person.



**CAUTION ELECTROSTATIC  
DISCHARGE SENSITIVE**

The PCB solution for product safety:

- Connect the cables only with the AC power off.
- Temporarily "short" the end of the cable before attaching it to any signal input or output.

### **Caution 2 – ESD sensitivity**

---

**ESD considerations should be made prior to performing any internal adjustments on the equipment.** Any item of electronic equipment is vulnerable to ESD when opened for adjustments. Internal adjustments should therefore be done **ONLY** at an ESD-safe work area. Many products have ESD protection, but the level of protection may be exceeded by extremely high voltage.

## Warranty

---

**A. Total Customer Satisfaction.** PCB guarantees **Total Customer Satisfaction** through its “Lifetime Warranty Plus” on all Platinum Stock Products sold by PCB and through its Limited Warranties on all other PCB Stock, Standard and Special products.

**B. Platinum Stock Products – Lifetime Warranty Plus.** Under PCB’s Lifetime Warranty Plus, if any PCB Platinum Stock Product ever fails, PCB will repair, replace or exchange the product at no charge. As a further benefit under PCB’s Lifetime Warranty Plus, PCB will, for a one (1) year period following the delivery date of any PCB Platinum Stock product, refund 100% of the customer’s purchase price paid for any such Product with which the original purchaser is not completely satisfied. This option of a refund may be selected in lieu of the repair, replacement or exchange of the product. “Platinum Stock Product” is defined as any PCB Stock Product designated by PCB from time-to-time as a “Platinum” model.

**C. Stock Products – Limited Warranty.** PCB warrants that all PCB Stock Products will be free from defects in materials and workmanship for a period of two (2) years from the date of original purchase. If any Stock Product shall fail during the warranty period, PCB will repair, replace or exchange it without charge. As a further benefit under PCB’s Limited Warranty for Stock Products, PCB will, for a (1) year period following the delivery date of any PCB Stock Product, refund 100% of the customer’s purchase price for any PCB Stock Product with which the original purchaser is not completely satisfied. “Stock Product” is defined to mean any product designated by PCB from time-to-time as a “Stock Product”. This is generally a product on which PCB customarily maintains finished goods inventory.

**D. Standard Products, Special Products and Test and Measurement Cables – Limited Warranty.** PCB warrants that all PCB Standards, PCB Specials and test and measurement cables will be free from defects in materials and workmanship for a period of one (1) year from the date of original purchase. If any PCB Standard or PCB Special shall fail during the warranty period, PCB will repair, replace or exchange it without charge. “PCB Standard” is a product regularly manufactured by PCB for which PCB does not customarily maintain finished goods inventory. “PCB Special” is defined as any customized or modified PCB product for which PCB does not customarily maintain finished goods inventory, or any other product PCB classifies as a special from time to time.

## Service

---

Because of the sophisticated nature of PCB instrumentation, field repair is typically not recommended and may void any warranty. If factory service is required, return the instrumentation according to the "Return Procedure" stated below. A repair and/or replacement quotation will be provided prior to servicing at no charge. Before returning the unit, please consult a factory PCB applications engineer concerning the situation because certain problems can often be corrected with simple on-site procedures.

## Return Procedure

---

To expedite returned instrumentation, contact a factory PCB Customer Service Representative for a RETURN MATERIAL AUTHORIZATION (RMA) NUMBER. When calling, please have information such as model, serial number and description of the problem available. When preparing the package for return, it is helpful to provide a written description of the symptoms and problems experienced with the equipment.

Customers outside the U.S. should consult their local PCB distributor for information on returning equipment. For exceptions, please contact the International Sales department at PCB to request shipping instructions and an RMA. For assistance, please call (716) 684-0003, or fax us at (716) 684-3823. You may also receive assistance via e-mail at <mailto:imi@pcb.com> or visit our web site at <http://www.pcb.com/>.

## Customer Service

---

PCB guarantees **Total Customer Satisfaction**. If, at any time, for any reason, you are not completely satisfied with any PCB product, PCB will repair, replace, or exchange it at no charge. You may also choose, within the warranty period, to have your purchase price refunded.

PCB offers to all customers, at no charge, 24-hour phone support. This service makes product or application support available to our customers, day or night, seven days a week. When unforeseen problems or emergency situations arise, call the **24 Hour SensorLine<sup>SM</sup> at 716 684-0001**, and an application specialist will assist you.



3425 Walden Avenue, Depew, NY 14043-2495  
**Phone** 716 684-0001 **Fax** 716 684-0987 **E-Mail** [info@pcb.com](mailto:info@pcb.com)  
**PCB** [www.PCB.com](http://www.PCB.com) **IMI** [www.IMI-Sensors.com](http://www.IMI-Sensors.com)

Certified to ISO 9001, AS-9100, ISO/IEC 17025

© 2013 PCB Group, Inc. In the interest of constant product improvement, specifications are subject to change without notice. All prices are subject to change without notice. PCB, ICP and Modally Tuned are registered trademarks of PCB Group, Inc. IMI and SensorLine are service marks of PCB Group, Inc. All other trademarks are properties of their respective owners.

Performance	ENGLISH	SI	
Sensitivity(± 5 %)(Voltage Output)	20.6 mV/pC	20.6 mV/pC	[1][2]
Sensitivity(± 5 %)(Current Output)	20.6 µA/pC	20.6 µA/pC	[1][2]
Input Range	± 242 pC	± 242 pC	
Low Frequency Response(- 3 dB)	10 Hz	10 Hz	[3][4]
High Frequency Response(- 1 dB)	5 kHz	5 kHz	[5][6][4]
Non-Linearity	≤ 1.0 % FS	≤ 1.0 % FS	
Environmental			
Temperature Range(Operating)	-22 to +185 °F	-30 to +85 °C	
Temperature Response(Sensitivity Deviation)	< 2.5 %	< 2.5 %	
Electrical			
Excitation Voltage	22 to 28 VDC	22 to 28 VDC	
Output Bias Voltage	7.3 to 7.7 VDC	7.3 to 7.7 VDC	
Output Voltage	± 5 Vpk	± 5 Vpk	
Output Bias Current	11 to 13 mA	11 to 13 mA	
Output Current	± 5 mApK	± 5 mApK	
Output Impedance	< 770 Ohm	< 770 Ohm	
Broadband Electrical Noise(1 to 10,000 Hz)	1,040 µV	-60 dB	[7][8]
Spectral Noise(1 Hz)	38 µV/√Hz	-88 dB	[7][8]
Spectral Noise(10 Hz)	54 µV/√Hz	-85 dB	[7][8]
Spectral Noise(100 Hz)	13 µV/√Hz	-98 dB	[7][8]
Spectral Noise(1 kHz)	10 µV/√Hz	-100 dB	[7][8]
Spectral Noise(10 kHz)	10 µV/√Hz	-100 dB	[7][8]
Resistance(Minimum required at input)	100,000 Ohm	100,000 Ohm	
Source Capacitance Loading	0.0009 %/pF	0.0009 %/pF	
Physical			
Housing Material	Aluminum	Aluminum	
Weight	6.5 oz	184 gm	

**OPTIONAL VERSIONS**

Optional versions have identical specifications and accessories as listed for the standard model except where noted below. More than one option may be used.

**NOTES:**

[1]Output can be set to either current or voltage output depending on the wiring configuration. See manual for wiring configuration.

[2]Set to provide a 350 mV/psi or 350 µA/psi output when using a 17 pC/psi pressure sensor. If used with a pressure sensor with a different sensitivity, the output sensitivity will vary.

[3]The low frequency tolerance is accurate within ±20% of the specified frequency.

[4]Frequency response tested with 1000pF input capacitor.

[5]Above stated frequency, the amplifier becomes slew rate limited.

[6]The high frequency tolerance is accurate within ±20% of the specified frequency.

[7]Tested using voltage source and input capacitor equal to the feedback capacitor, to simulate a charge output sensor.

[8]Typical.

[9]See PCB Declaration of Conformance PS024 for details. A low impedance connection from case to earth ground is required to maintain CE compliance.



All specifications are at room temperature unless otherwise specified.

In the interest of constant product improvement, we reserve the right to change specifications without notice.

ICP® is a registered trademark of PCB Piezotronics, Inc.

Entered: LK	Engineer: AJP	Sales: MC	Approved: NJF
Date: 11/05/2019	Date: 11/05/2019	Date: 11/05/2019	Date: 11/05/2019

Spec Number:	71008
--------------	-------



Phone: 716-684-0001  
 Fax: 716-684-0987  
 E-Mail: info@pcb.com

3425 Walden Avenue, Depew, NY 14043

PCB Piezotronics Inc. claims proprietary rights in the information disclosed hereon. Neither it nor any reproduction thereof will be disclosed to others without the written consent of PCB Piezotronics Inc.

REVISIONS		
REV	DESCRIPTION	DIN
NR	RELEASED TO DRAFTING	49931

70283

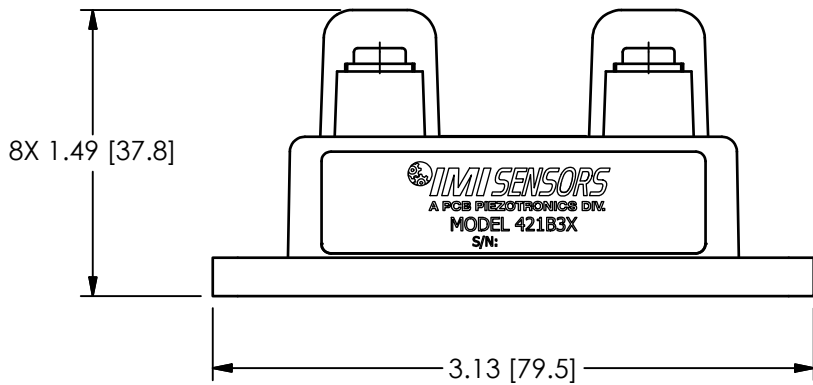
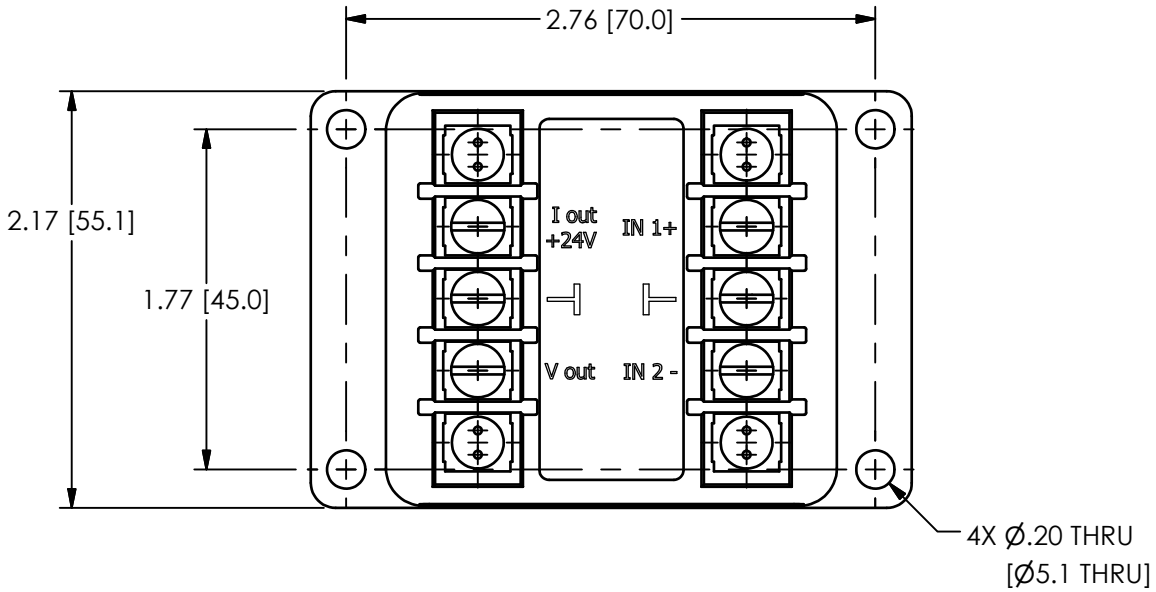

UNLESS OTHERWISE SPECIFIED TOLERANCES ARE:		DRAWN		CHECKED		ENGINEER		 3425 WALDEN AVE. DEPEW, NY 14043 (716) 684-0001 E-MAIL: sales@pcb.com		
DIMENSIONS IN INCHES	DIMENSIONS IN MILLIMETERS [ IN BRACKETS ]	JES	10/28/19	JDM	10/28/19	AJP	10/28/19			
DECIMALS XX ±.03 XXX ±.010	DECIMALS X ± 0.8 XX ± 0.25	TITLE OUTLINE DRAWING MODEL 421B3X CHARGE AMPLIFIER							CODE IDENT. NO. 52681	DWG. NO. 70283
ANGLES ± 2 DEGREES	ANGLES ± 2 DEGREES								SCALE: FULL	SHEET
FILLETS AND RADII .003 - .005	FILLETS AND RADII 0.07 - 0.13									