



Model 482C27

Bridge/Differential, ICP®/Voltage Sensor Signal Conditioner

Installation and Operating Manual

**For assistance with the operation of this product,
contact PCB Piezotronics, Inc.**

**Toll-free: 800-828-8840
24-hour SensorLine: 716-684-0001
Fax: 716-684-0987
E-mail: info@pcb.com
Web: www.pcb.com**



Repair and Maintenance

PCB guarantees Total Customer Satisfaction through its “Lifetime Warranty Plus” on all Platinum Stock Products sold by PCB and through its limited warranties on all other PCB Stock, Standard and Special products. Due to the sophisticated nature of our sensors and associated instrumentation, **field servicing and repair is not recommended and, if attempted, will void the factory warranty.**

Beyond routine calibration and battery replacements where applicable, our products require no user maintenance. Clean electrical connectors, housings, and mounting surfaces with solutions and techniques that will not harm the material of construction. Observe caution when using liquids near devices that are not hermetically sealed. Such devices should only be wiped with a dampened cloth—never saturated or submerged.

In the event that equipment becomes damaged or ceases to operate, our Application Engineers are here to support your troubleshooting efforts 24 hours a day, 7 days a week. Call or email with model and serial number as well as a brief description of the problem.

Calibration

Routine calibration of sensors and associated instrumentation is necessary to maintain measurement accuracy. We recommend calibrating on an annual basis, after exposure to any extreme environmental influence, or prior to any critical test.

PCB Piezotronics is an ISO-9001 certified company whose calibration services are accredited by A2LA to ISO/IEC 17025, with full traceability to SI through N.I.S.T. In addition to our standard calibration services, we also offer specialized tests, including: sensitivity at elevated or cryogenic temperatures, phase response, extended high or low frequency response, extended range, leak testing, hydrostatic pressure testing, and others. For more information, contact your local PCB Piezotronics distributor, sales representative, or factory customer service representative.

Returning Equipment

If factory repair is required, our representatives will provide you with a Return Material Authorization (RMA) number, which we use to reference any information you have already provided and expedite the repair process. This number should be clearly marked on the outside of all returned package(s) and on any packing list(s) accompanying the shipment.

Contact Information

PCB Piezotronics, Inc.
3425 Walden Ave.
Depew, NY14043 USA
Toll-free: (800) 828-8840
24-hour SensorLine: (716) 684-0001
General inquiries: info@pcb.com
Repair inquiries: rma@pcb.com

For a complete list of distributors, global offices and sales representatives, visit our website, www.pcb.com.

Safety Considerations

This product is intended for use by qualified personnel who recognize shock hazards and are familiar with the precautions required to avoid injury. While our equipment is designed with user safety in mind, the protection provided by the equipment may be impaired if equipment is used in a manner not specified by this manual.

Discontinue use and contact our 24-Hour Sensorline if:

- Assistance is needed to safely operate equipment
- Damage is visible or suspected
- Equipment fails or malfunctions

For complete equipment ratings, refer to the enclosed specification sheet for your product.

Definition of Terms and Symbols

The following symbols may be used in this manual:



DANGER

Indicates an immediate hazardous situation, which, if not avoided, may result in death or serious injury.

**CAUTION**

Refers to hazards that could damage the instrument.

**NOTE**

Indicates tips, recommendations and important information. The notes simplify processes and contain additional information on particular operating steps.

The following symbols may be found on the equipment described in this manual:



This symbol on the unit indicates that high voltage may be present. Use standard safety precautions to avoid personal contact with this voltage.



This symbol on the unit indicates that the user should refer to the operating instructions located in the manual.



This symbol indicates safety, earth ground.



PCB工业监视和测量设备 - 中国RoHS2公布表

PCB Industrial Monitoring and Measuring Equipment - China RoHS 2 Disclosure Table

部件名称	有害物质					
	铅 (Pb)	汞 (Hg)	镉 (Cd)	六价铬 (Cr(VI))	多溴联苯 (PBB)	多溴二苯醚 (PBDE)
住房	0	0	0	0	0	0
PCB板	X	0	0	0	0	0
电气连接器	0	0	0	0	0	0
压电晶体	X	0	0	0	0	0
环氧	0	0	0	0	0	0
铁氟龙	0	0	0	0	0	0
电子	0	0	0	0	0	0
厚膜基板	0	0	X	0	0	0
电线	0	0	0	0	0	0
电缆	X	0	0	0	0	0
塑料	0	0	0	0	0	0
焊接	X	0	0	0	0	0
铜合金/黄铜	X	0	0	0	0	0
本表格依据 SJ/T 11364 的规定编制。						
0：表示该有害物质在该部件所有均质材料中的含量均在 GB/T 26572 规定的限量要求以下。						
X：表示该有害物质至少在该部件的某一均质材料中的含量超出 GB/T 26572 规定的限量要求。						
铅是欧洲RoHS指令2011/65/ EU附件三和附件四目前由于允许的豁免。						

CHINA RoHS COMPLIANCE

Component Name	Hazardous Substances					
	Lead (Pb)	Mercury (Hg)	Cadmium (Cd)	Chromium VI Compounds (Cr(VI))	Polybrominated Biphenyls (PBB)	Polybrominated Diphenyl Ethers (PBDE)
Housing	O	O	O	O	O	O
PCB Board	X	O	O	O	O	O
Electrical Connectors	O	O	O	O	O	O
Piezoelectric Crystals	X	O	O	O	O	O
Epoxy	O	O	O	O	O	O
Teflon	O	O	O	O	O	O
Electronics	O	O	O	O	O	O
Thick Film Substrate	O	O	X	O	O	O
Wires	O	O	O	O	O	O
Cables	X	O	O	O	O	O
Plastic	O	O	O	O	O	O
Solder	X	O	O	O	O	O
Copper Alloy/Brass	X	O	O	O	O	O

This table is prepared in accordance with the provisions of SJ/T 11364.

O: Indicates that said hazardous substance contained in all of the homogeneous materials for this part is below the limit requirement of GB/T 26572.

X: Indicates that said hazardous substance contained in at least one of the homogeneous materials for this part is above the limit requirement of GB/T 26572.

Lead is present due to allowed exemption in Annex III or Annex IV of the European RoHS Directive 2011/65/EU.

SIGNAL CONDITIONER

Model 482C27

GENERAL OPERATION MANUAL

For powering differential voltage MEMS, single ended MEMS and bridge (quarter, full, half) sensors, this signal conditioner provides an effective method for managing small numbers of sensor channels. A simple command set, entered through industry standard interface, allows the user to generate powerful application-specific programs to automate system testing. A front panel interface is provided for easy control and operation. This conditioner also includes ICP® power.

Manual Number: 43265

Manual Revision: D

ECO Number: 49597



PCB PIEZOTRONICS, INC. 3425 WALDEN AVENUE DEPEW, NY 14043-2495 PHONE 716-684-0001 FAX 716-684-0987

®ICP is a registered trademark of PCB Group, Inc.

KS398

Table of Contents

Table of Contents	i
1-0. INTRODUCTION AND SPECIFICATIONS	1
1-1. Introduction: Safety Considerations	1
1-2. Model 482C27 System Description	2
1-2.1 Model 482C27 ICP® Input/Output Mode	2
1-3. Block Diagram	3
1-4. Installation	3
1-4.1 Grounding Techniques	3
1-4.2 Quick Set-up Instructions	4
1-5. Operation: Standard AC Line	7
1-6. Maintenance and Repair	7
2-0. FRONT PANEL MODULE CONTROL	7
2-1. Introduction	7
2-2. Unit Initialization	7
The factory defaults are:	7
2-3. Main Menu Format	7
2-4. Submenu Format and Command Selections	8
3-0. THEORY OF OPERATION	19
3-1. Sensor Excitation	19
3-2. Input Protection	20
3-3. Input Fault Detection	20
3-4. Input Interface	20
3-5. Normalized Output Sensitivity	20
3.6 Auto Scaling and Overload Detection	21
3-6.1 Auto Scale	21
3-6.2 Overload	21
3-7. Connector Configuration	22
3-8. Channel Input Mode Selection	22
3-9. Bridge/Differential/RSE/NRSE Sensor Connection	22
3-10. RS-232 & Ethernet connections	22
3-11. Non-Volatile Memory	22
3-12. Transducer Electronic Data Sheet (TEDS) Interface:	22
4-0. COMPUTER INTERFACE PROGRAMMING GUIDE	23

4-1.	Introduction	23
4-2.	RS-232	23
4-3.	RS-232 Host Set-Up	23
4-4.	RS-232 Rear Panel Pinout Listing	23
4-5.	Ethernet Communication	23
4-6.	Model 482C27 Communication Guidelines	30
4-7.	Model 482C27 Unit Initialization Procedure	30
4-8.	Command Summary	30
4-9.	Command Format	31
4-10.	Commands	32
	GAIN	32
	SENS	32
	FSCI	32
	FSCO	33
	INPT	33
	IEXC	34
	VEXC	34
	FLTR	35
	OFLT	35
	CLMP	36
	CPLG	36
	SWOT	36
	CALB	37
	RTED	37
	ALLC	38
	RBIA	38
	CHRD	38
	STUS	39
	UNIT	39
	UNID	40
	AZZR	41
	LEDS	41
	RSET	41
	AUTR	42

SAVS	42
Communication Responses	43
5-0. Wiring Information	44
5-1. Differential Voltage & Full Bridge Mode	44
5-2. Half Bridge Mode	45
5-3. Quarter Bridge Mode	46
5-4. RSE / NRSE Mode for 3 Wire Sensors	46
5-5. Connection of Triaxial Sensors	47
Figure 1 Typical Block Diagram of Model 482C27	3
Figure 2 ICP® Sensor Excitation	19
Figure 3 Input Fault Window Comparator with LED Indicator	20
Figure 4 Input Amplifier Configuration	20
Figure 5 Autoscale/Overload Window Comparator	21
Figure 6 Differential Voltage/Full Bridge Type Sensor Connection	44
Figure 7 Alternate Connections for Differential Voltage/Full Bridge Type Sensors	45
Figure 8 Recommended Connections for Half Bridge Type Sensors	45
Figure 9 Recommended Connections for Quarter Bridge Type Sensors	46
Figure 10 Recommended Connections for 3 Wire Type Sensor	46
Figure A1 Settings for Differential MEMS Sensors	47
Figure A2 Settings for Single Ended MEMS Sensors	48

1-0. INTRODUCTION AND SPECIFICATIONS

1-1. Introduction: Safety Considerations

WARNING SYMBOLS AND TERMS

The following symbols and terms may be found on the equipment described in this manual.



This symbol on the unit indicates that the user should refer to the operating instructions located in the manual.



This symbol on the unit indicates that high voltage may be present. Use standard safety precautions to avoid personal contact with this voltage.



This symbol indicates that the test fixture, Model 482C, must be connected to earth ground via the power cord.

The **WARNING** heading used in this manual explains dangers that might result in personal injury or death. Always read the associated information very carefully before performing the indicated procedure.

The **Caution** heading used in this manual explains hazards that could damage the instrument.

WARNING 1: *The power supply/signal conditioner should not be opened by anyone other than qualified service personnel.* This product is intended for service by qualified personnel who recognize shock hazards and are familiar with the safety precautions required to avoid injury.

WARNING 2: This equipment is designed with user safety in mind; however, the protection provided by the equipment may be impaired if the equipment is used in a manner not specified by PCB Piezotronics, Inc.

Caution 1: *Cables can kill your equipment.* High voltage Electro Static Discharge (ESD) can damage electrical devices. Similar to a capacitor, a cable can hold a charge caused by triboelectric transfer, such as that which occurs in the following:

- Laying on and moving across a rug.
- Any movement through air.
- The action of rolling out a cable.
- Contact to a non-grounded person

The solution for product safety: 1) Connect the cables only with the AC power off. 2) Temporarily “short” the end of the cable before attaching it to any signal input or output.

Caution 2: *ESD considerations should be made prior to performing any internal adjustments on the equipment.* Any piece of electronic equipment is vulnerable to ESD when opened for adjustments. Internal adjustments should therefore be done **ONLY** at an ESD-safe work area. Many products have ESD protection, but the level of protection may be exceeded by extremely high voltage that is typically present in normal situations.

EQUIPMENT RATINGS

For complete specifications, please refer to the product spec sheet. This equipment operates optimally at +32 to +120°F (0 to +50°C), in an environment having <85% relative humidity. The line power frequency range is 50/60 Hz.

482C27 requires 10-15 VDC with 500 mA to operate. The unit receives power from a supplied 12 VDC universal AC power adaptor.

1-2. Model 482C27 System Description

Model 482C27 is a four-channel, bench top signal conditioner that offers low noise operation and simplicity of use. Each channel is selectable between several input types: Differential Voltage, Non-referenced Single Ended (NRSE), Referenced Single Ended (RSE), ICP®, Voltage, Bridge (full, half and quarter). NOTE – NRSE and RSE input modes are for 3-wire sensors that have separate power and signal output connections and a ground connection.

For NRSE, RSE, differential voltage and bridge modes this model offers up to 12 VDC unipolar or bipolar excitation voltage. These input modes feature incremental gain of x0.1 to x2000, normalization, shunt calibration and AC/DC coupling. In DC coupled mode, auto balance and auto zero functions automatically compensate the internal circuitry to provide a zero based output.

The two main input modes for MEMS sensors are:

Differential Voltage – Main use is with MEMS sensors that have a differential output. Sensor examples are PCB model series 3501, 3503, 3641, 3651, 3741 and 3991.

Referenced Single Ended – Main use is with MEMS sensors that have a single ended output. Sensor examples are PCB model series 3711 and 3713.

The bridge inputs are compatible with full, ½ and ¼ bridge sensors. Internal switchable bridge completion resistors are included in the unit (resistance value of 350Ω). The maximum current available is 30mA, with a current limit set at 40mA to prevent damage from inadvertent shorting.

For the ICP® inputs, the model offers up to 20 mA of constant current excitation to power ICP® sensors or in-line ICP® charge converters. The ICP® and Voltage input feature incremental gain of x.1 to x200, normalization, and AC/DC coupling. In DC coupled mode, an auto zero function is available to automatically compensate the internal circuitry to provide a zero based output. In Voltage input mode current excitation is set to 0 mA (off).

Model 482C27 offers the following:

- Compatible with PCB's line of MEMS DC accelerometers (model series 3711, 3713, 3501, 3503, 3741, 3991)
- Provides power for ICP® sensors
- Compatible with full, ½, and ¼ bridge sensors
- Suitable for conditioning any voltage input signals
- AC/DC coupling selectable per channel
- Auto zero and Auto balance functions
- Gain of 0.1 to 2000 for bridge inputs
- Gain of 0.1 to 200 for ICP®/voltage inputs
- Keypad and menu-driven dot matrix display
- Computer control via either RS-232 or Ethernet using the supplied PCB software

1-2.1 Model 482C27 ICP® Input/Output Mode

482C27 contains a regulated 24 VDC power supply that provides constant current for up to 4 individual channels. Both the output and input connections utilize BNC connectors and are brought out through the rear panel. The 8-pin DIN connectors are NOT used in ICP® mode.

1-3. Block Diagram

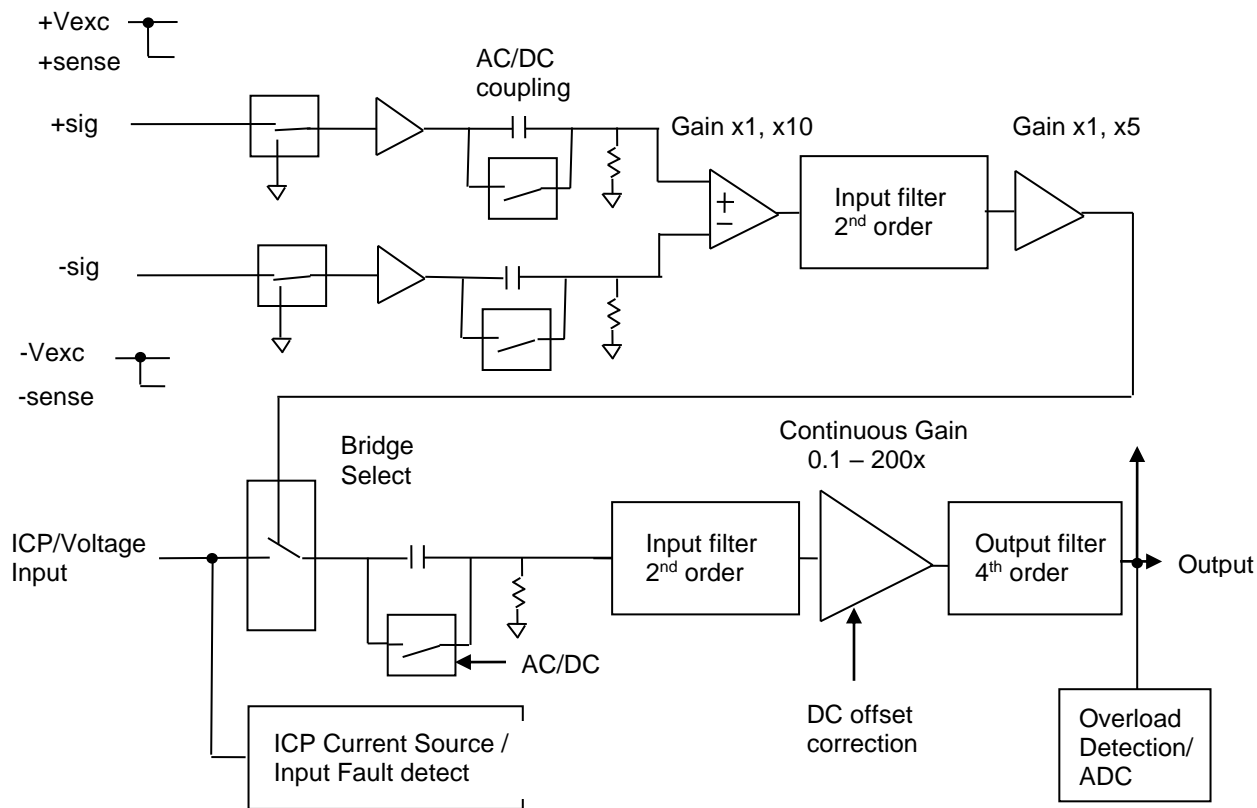

Figure 1 Typical Block Diagram of Model 482C27

1-4. Installation

Model 482C27 comes in the form of a standard box. The box should be located in such a way as to allow convenient access to the power outlet for disconnect purposes. Since this unit has low power consumption, it can be located in confined environments.

1-4.1 Grounding Techniques

Integrating model 482C27 into an application that links the outputs to other test equipment powered by line voltages may lead to errors or loss of signal-to-noise ratio due to ground loops. The evidence of ground loops is easily seen whenever the fundamental frequency (50 or 60 Hz) or a multiple of the fundamental frequency is present in the system when the sensors are at rest. In order to maintain the operating specification of noise and reduce the effects of line interference, proper grounding techniques should be used. The following procedure may be helpful:

1. Make sure the signal ground lines of all equipment are tied together. The signal grounds of the channels are typically tied together via the case of the input and output BNC connectors. The individual channels of model 482C27 have their signal ground lines tied together internally at the power supply.

2. Insure that the sensor does not pick up line noise from the body under test. The case of the sensor should be isolated from the test structure (ground) using an isolation pad. The isolation pad breaks the loop formed by the signal path of the sensor to model 482C27 and the return (ground) from the signal conditioner back to the sensor.

3. Make sure that all equipment signal grounds of the test system are tied to the Earth ground at a single point and the connections linking the equipment ground are made using a wire that can provide a very low impedance connection.

1-4.2 Quick Set-up Instructions

1-4.2a Front Panel Introduction

The following illustration shows the front panel module as it appears on model 482C27 when initially powered on.

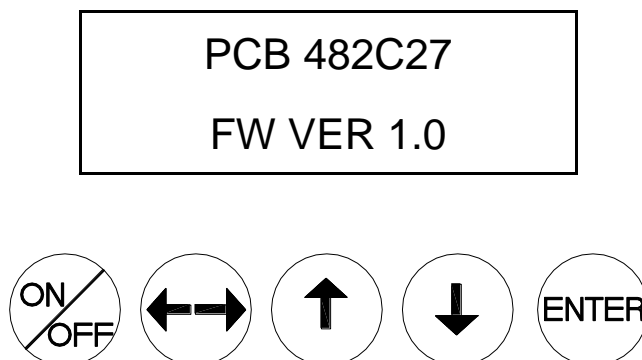

▼ This button is used to scroll DOWN through the options in the menu. In the submenu, this button can be used to change the channel and increments.

▲ This button is used to scroll UP through the options in the menu. In the submenu, this button can be used to change the channel and increments.

← → This button moves you in the right direction through the menus and submenus.

ENTER: This button applies the setting of the option selected, while exiting the user out of the submenu.

NOTE: Please refer to section 1-4.2b and 1-4.2c for instructions on how to set the mode and gain options. The settings for these options should be considered before unit is used to collect data.

NOTE: In the Submenus a flashing cursor represents a menu that will accept user input. A non-flashing cursor represents a status menu, no input needed.

1-4.2b Setting the sensor input type

The input type option lets the user switch between Differential Voltage, Non-referenced Single Ended (NRSE), Referenced Single Ended (RSE), ICP®, Voltage, and Bridge (full, half and quarter) modes. The factory default for all channels is ICP®. To change the input type select the **INPT** option from the main menu use the down ↓ arrow button to scroll down and the left / right ←→ button until the cursor is over the **INPT** option, and hit the <ENTER> key.

GAIN	SENS	INPT
FSOT	FSIN	FLTi

A submenu will appear. Choose the channel you wish to change by using the up ↑ or down ↓ arrows. Once that is done use the left / right ←→ button to move the cursor over to the **INPT** column. To change the input, use either the up ↑ or down ↓ arrow to scroll through the options. The channels can be in **ICP®**, **Voltage**, **Differential Voltage**, **Full Bridge**, **Half Bridge**, **Quarter Bridge**, **Non Referenced Single Ended (NRSE)** or **Referenced Single Ended (RSE)** mode. Once it is set, either scroll back to the channel column to change the mode on another channel or hit **ENTER** to save the changes.

Example: If you want to change channel 2 to be in Full Bridge mode you would perform the following steps:

Scroll and select **INPT** from the main menu, and hit enter. Once in the submenu, the flashing cursor will be in the channel column, hit the up ↑ arrow button until the channel column reads 2.

Chan	Input Type
2	ICP

Hit the left / right ←→ arrow key once so that the cursor is over the **INPT** column. Use the up ↑ or down ↓ arrow keys until the mode says BRG FULL.

Chan	Input Type
2	BRG FULL

Once you have hit enter, your changes will be saved.

NOTE: To make a global change (set all the channels to the same mode) set the channel to ALL.

Chan	Input Type
All	BRG FULL

NOTE: Setting a channel to NRSE, RSE, Voltage, Differential voltage or Bridge (full, ¼, ½) mode will cause the ICP® current source for that channel to be turned off, 0 mA. The voltage excitation (EXCv) must be set after selecting one of these input modes. Conversely, if ICP® is set from another input mode then the ICP® current source will be set to 4mA. Exiting NRSE, RSE, Differential voltage or Bridge (full, ¼, ½) mode will cause the voltage excitation to be set to 0V for that channel.

1-4.2c Directly setting the gain

To enter the submenu for the incremental gain in the 482C27, place the cursor over the word GAIN in the main menu. This is shown as:

GAIN	SENS	INPT
FSOT	FSIN	FLTi

By pressing the ENTER button, the submenu for changing the gain of any channel appears on the display. The submenu pertaining to the GAIN selection appears as:

Channel	Gain
1	001.0

Example: To set the gain of Channel 2 to x10, perform the following steps:

The flashing cursor appears over the channel selection. Choose the channel you wish to change by using the up↑ or ↓ arrows. Once you have selected the channel, use the left/right ←→ arrow key to move the flashing cursor over to the gain column.

Channel	Gain
2	001.0

To change the gain, use the up↑ and down↓ arrow keys to scroll through the options. Model 482C27 has incremental gain selectable from .1 to 200.0 (step of .1). Use the left/right ←→ arrow key to move the flashing cursor over any digit in the gain column to select an appropriate value.

In this example, a gain of 10 is selected (see example below). As with all setting changes, the actual gain internal to the unit is changed when the ENTER button is pushed.

Channel	Gain
2	010.0

To set the next channel, press the left right ←→ arrow key to resume channel control, then press the up↑ or down↓ arrow keys to select a different channel. Continue making selections with the directional keys until all desired channels are set, then press the ENTER key to return to the option menu.

NOTE: To do a global change (set all the channels to the same gain) set the channel to ALL. If the global method of changing channel gains is employed and one or more channels are set to input types that do not support the selected gain setting then those channels will be set to their maximum value. For example, if channels 1 & 2 are set to Full Bridge and 3 & 4 are set to ICP® and the user sets the gain channel option to 'ALL' with a value of 1000, then the Bridge channels

will be set to 1000 but the ICP® channels will be set to 200 because that input type has a gain limit of 200 and cannot be set to 1000.

NOTE: For more information on gain, please see section 2-4 (#1 – Gain Functionality).

1-5. Operation: Standard AC Line

Plug the adapter into any 100 - 240 VAC 47 - 63 Hz power source, attach the supplied ferrite clamp on the AC cord to ensure CE conformance. The ferrite clamp should be placed as close to the signal conditioner as possible. Press the “ON/OFF” button to turn the unit on.

CAUTION: Refer to the rear panel for proper input voltage and currents.

1-6. Maintenance and Repair

It is not recommended that the customer attempt to repair model 482C27 in the field. Should trouble occur, contact the factory for assistance. If the unit becomes dusty and dirty, it may be wiped off with a soft cloth.

2-0. FRONT PANEL MODULE CONTROL

2-1. Introduction

Model 482C27 is equipped with the capability of controlling functions through the front panel module. This module consists of a display and five (5) push buttons. The display shows various menus in which all of the available options are given. The user may scroll through the menu, and choose any option to change the settings.

2-2. Unit Initialization

Upon pressing the ON/OFF button, the unit will turn on and display the following:

PCB 482C27
FW Ver n.n

The unit is initialized, with the factory default settings.

The factory defaults are:

- Gain = 1.0
- Gain Type = Gain
- Sensitivity = 10.0
- Full Scale input = 1000.0
- Full Scale output = 10.0
- Input Mode = ICP®
- Input Filter = Disabled
- Current excitation = 4.0 mA
- Output Filter = Disabled
- Coupling = AC
- Clamp = OFF

2-3. Main Menu Format

Initially, pressing any button will cause the first two menu lines to be displayed and the cursor will blink on the ‘Gain’ option.

GAIN	SENS	INPT
FSOT	FSIN	FLTi

The cursor may be moved around the main menu by using the arrow keys. To show the other selections of the main menu, press the down ↓ arrow key. This action scrolls vertically to the subsequent lines on the menu. These lines are shown below.

EXCi	EXCv	FLTo
ACDC	ZERO	ARNG
SWOT	CLMP	Bias
CHRD	Cal	LEDS
Ver?	Unit	Reset
Disp	Savs	GType

Pressing the down ↓ arrow key button once again shows:

GAIN	SENS	INPT
FSOT	FSIN	FLTi

2-4. Submenu Format and Command Selections

1) Gain Functionality – Includes five menu selections

The following menu options all pertain to how the gain functionality operates in the 482C27.

Gain Type (GType on front panel): Allows the user to choose how the gain of each channel can be set. The selections in the submenu are Gain and Normalize (Gain is the factory default setting). Pressing ENTER brings up the submenu shown below. The up ↑ and down ↓ arrow key can be used toggle between the two options.

Gain Set Option
Gain

Both options return control to the main menu after a selection is made. If Gain is selected then only the **GAIN** menu item can be used to set the gain of a channel. If Normalize is selected then the **GAIN** menu item is disabled and **SENS**, **FSOT** and **FSIN** will be used to set the gain using this equation: $\text{Gain} = (\text{FSOT} * 1000) / (\text{FSIN} * \text{SENS})$.

If the user attempts to use a menu selection (**SENS**, **FSOT**, **FSIN**, **GAIN**) that conflicts with the **GType** setting the message 'Invalid Item for Gain Entry Type' will be displayed.

Gain (GAIN on front panel): Directly sets the gain value of each channel. For ICP®/voltage input modes: .1 to 200.0. For NRSE, RSE, differential voltage and bridge input modes: .1 to 2000.0. **GType** must be set to the Gain selection. See section 1-4.2C for instructions on setting the gain directly. The gain step is .1.

Sensitivity (SENS on front panel): The sensor sensitivity is entered here using the ←→ and ↑↓ arrow keys and then hitting Enter. **GType** must be set to the Normalize selection.

Full Scale Input (FSIN on front panel): The estimated full scale mechanical input (ex – engineering units, g's, psi, bar, etc.) is entered here using the ←→ and ↑↓ arrow keys and then hitting Enter. **GType** must be set to the Normalize selection.

Full Scale Output (FSOT on front panel): The desired full scale output voltage is entered here using the ←→ and ↑↓ arrow keys and then hitting Enter. **GType** must be set to the Normalize selection.

The submenus for **SENS**, **FSIN** and **FSOT** appear like this:

Chan	Sensitivity	Chan	FS In	Chan	FSOT
2	00100.000	2	01000.000	2	0010.0

The 482C27 has the ability to automatically normalize the output sensitivity of each channel based on the sensitivity of the sensor (**SENS**), the full scale value of the input (**FSIN**) in engineering units (g's for example) and the full scale output (**FSOT**) of the amplifier expressed in volts (this is the output that a signal at an **FSIN** level will produce). As stated previously, the gain equation is:

$$\text{Gain} = (\text{FSOT} * 1000) / (\text{FSIN} * \text{SENS})$$

Normalized Output Example: A full scale output of 5 volts is desired and a full scale input of 380 engineering units is expected. The sensor sensitivity is 9.96 mV/g. These values should be entered into **FSOT**, **FSIN** and **SENS** respectively. The gain will be automatically set to 1.3 to give a 5 volt full scale output based on the expected input and sensor sensitivity.

$$\text{Gain} = (5 * 1000) / (380 * 9.96) = 1.3$$

Normalization is useful when standardizing the output of channels with sensors of different sensitivities. Consider the following example where 1V/unit standardization on each channel is desired:

<u>Channel</u>	<u>Sensor Sensitivity</u>	<u>Gain Setting</u>	<u>Actual Gain Needed</u>
1	10.10 mV/unit	99.00	99.01
2	101.32 mV/unit	9.9	9.869
3	22.30 mV/unit	44.8	44.84

NOTE: The **GAIN** menu selection will not show what the gain is set at when in the Normalize **GType** setting, but the front panel will display the gain value of each channel (to the best accuracy possible) if the Display Content Option is set to show gain. See Display Content Option for more detail.

2) Sensor Input Mode (INPT on front panel):

See section 1-4.2b.

3) Input Filter (FLTi on front panel):

A screen stating 'This Option is Not Installed' will appear. The 482C27 does not come standard with an input filter, but the option is available. Contact the factory for more information.

Each channel's input filter setting can be set independently of the other channels. To change the input filter setting from the main menu, use the left / right \leftrightarrow arrow keys until the cursor is over the FLTi option, and then press the Enter button.

GAIN	SENS	INPT
FSOT	FSIN	FLTi

The following submenu will appear. Choose the channel you wish to change by using the up \uparrow and down \downarrow arrow keys. Next, use the left / right \leftrightarrow arrow key to move the flashing cursor over to the INP filter column. To change the filter setting, use either the up \uparrow or down \downarrow arrow key to select either 'On' or 'Off', once you have the desired setting selected hit ENTER to apply it.

Chan	INP Filter
2	Off

4) Output Filter (FLTo on front panel):

A screen stating 'This Option is Not Installed' will appear. The 482C27 does not come standard with an output filter, but the option is available. Contact the factory for more information.

Each channel's output filter setting can also be set independently of the other channels. To change the output filter setting from the main menu, use the left / right \leftrightarrow arrow keys until the cursor is over the FLTo option, and then press the Enter button.

EXCi	EXCv	FLTo
ACDC	ZERO	ARNG

The following submenu will appear. Choose the channel you wish to change by using the up \uparrow and down \downarrow arrow keys. Next, use the left / right \leftrightarrow arrow key to move the flashing cursor over to the Out Filter column. To change the filter setting, use either the up \uparrow or down \downarrow arrow key to select either 'On-nn.nk' or 'Off', once you have the desired setting selected hit ENTER to apply it.

NOTE: The ON setting also indicates the filter corner frequency, in kHz, implemented by the filter for the channel.

Chan	Out Filter
2	ON-10.0k

5) ICP® Current Adjustment (EXCi on front panel):

The current excitation value can be set from 0 – 20 mA, where 0 = Off. To set the current excitation value, move the cursor to the 'EXCi' location, as shown below.

EXCi	EXCv	FLTo
ACDC	ZERO	ARNG

Pressing the ENTER button, will cause the following submenu to appear. The ICP® current may be altered by using the up ↑ or down ↓ arrow keys.

Chan	ICP Current
4	02 mA

The 482C27 will turn off the current excitation signal if the unit is not in ICP® input mode and will not allow it to be set while unless it is in ICP® mode. If a channel is selected from the EXCi menu that is inappropriate then **NA** will appear as shown below in place of the ICP® current settings. Also, because of this limitation, the 'ALL' channel selection is not allowed for this setting.

Chan	ICP Current
2	NA

NOTE: The factory default setting for the ICP® current is 4 mA.

6) Voltage Excitation (EXCv on the front panel):

NOTE: This menu selection is for Differential Voltage, RSE, NRSE and bridge (full, half and quarter) input modes ONLY. It is NOT for the Voltage input mode.

The voltage excitation value can be set from -12.00 to +12.00 V. A positive entry forces a unipolar setting and a negative entry forces a bipolar entry. 0 = Off. To set the voltage excitation value, move the cursor to the 'EXCv' location, as shown below.

EXCi	EXCv	FLT0
ACDC	ZERO	ARNG

Pressing the ENTER button, will cause the following submenu to appear. The voltage excitation may be altered by using the up ↑ or down ↓ arrow keys to adjust the voltage value. Traversing the menu once more provides the option to select UNI – unipolar or BI – bipolar settings. Changing these will also force the sign of the voltage excitation value to the appropriate value.

Ch	Vexc	Polarity
4	10.00	UNI

The 482C27 will turn off the voltage excitation signal if the unit is in ICP® or voltage input mode and will not allow it to be set while in those modes. If a channel is selected from the EXCv menu that is inappropriate then **NA** will appear as shown below in place of the voltage and polarity settings. Also, because of this limitation, the ‘ALL’ channel selection is not allowed for this setting.

Ch	Vexc	Polarity
2	NA	NA

NOTE: The factory default setting for voltage excitation is 0.

7) Input Coupling (ACDC on front panel):

482C27 provides an option for AC or DC coupling. The AC coupled mode passes the signal through a DC blocking capacitor or high pass filter to remove the sensor bias voltage.

EXCi	EXCv	FLT0
ACDC	ZERO	ARNG

When the ENTER button is pressed while over ACDC, the submenu for the coupling options will include; **AC, DC**. The selection can be changed by using the up ↑ or down ↓ buttons.

Chan	Coupling
1	DC

The coupling options are AC or DC. In DC coupling mode the auto zero and auto balance functions become available. Auto zero is for all input types and auto balance is for the Differential Voltage and Bridge (full, half and quarter) input types.

8) Auto Zero/ Auto Balance (ZERO on front panel):

482C27 includes an auto zero function for automatically zeroing channel outputs for any channel in DC coupling mode (zeroing works for any sensor input type). The auto balance function works for channels that are set to differential voltage, bridge (quarter, full, half), RSE and NRSE input modes ONLY (when DC coupling is enabled). Both zeroing functions are not available when a channel is AC coupled. The auto zero function disconnects the input and uses a DAC to reduce the channel output to close to 0V. The balance option does the same but leaves the input connected.

EXCi	EXCv	FLT _o
ACDC	ZERO	ARNG

When the ENTER button is pressed, the submenu for the coupling options will include; **Cancel**, **AUTOBAL**, **AUTOZERO**. The selection can be changed by using the up ↑ or down ↓ buttons.

Chan	AUTOZERO
1	AUTOBAL

NOTE: If the zero function fails either the message “Error Removing MainBd DC Offset” or “Error Removing Bridge DC Offset” will be displayed depending on the situation. For gains less than 500 the function tries to get below 2mV output and gains less than or equal to 500, 50mV is the limit.

9) Auto Range (ARNG on front panel):

The auto range (also referred to as auto scale) feature provides an automatic scaling of the output signal. Please refer to section 3-6.1 for further description. With this command, the programmable gain is implemented to give .8 of the full scale output. The signals are checked internally using the onboard A/D. To use this feature, place the cursor over “ARNG” on the display and press the ENTER key, the following submenu will appear.

EXCi	EXCv	FLT _o
ACDC	ZERO	ARNG

Use the up ↑ or down ↓ arrow keys to toggle between the ‘OFF’, ‘ON’ or ‘IMED’ options. Once you have set the auto scale option, hit the ENTER key to return to the main menu. ON turns the auto scale function ON and it will continue scaling the gain until it is manually turned off. The ‘IMED’ option runs through the auto scale algorithm once and then turns it off automatically.

Chan	Autoscale
2	Off

NOTE: The auto scale option should NOT be left on while measurements are being taken. It is strictly to be used during the setting of the gain and should be turned off when complete.

10) Switched Output (SWOT on front panel):

Switched output capability is not applicable to the 482C27. A 'This Option is Not Installed' message will appear if it is selected.

SWOT	CLMP	Bias
CHRD	Cal	LEDS

11) Clamp (CLMP on the front panel):

The clamp function is not applicable to the 482C27. A 'This Option is Not Installed' message will appear if it is selected.

SWOT	CLMP	Bias
CHRD	Cal	LEDS

12) Bias Measurement (Bias on the front panel):

The 482C27 is capable of measuring the bias voltage present on each of its channels. By moving the cursor upon the bias location, the display appears as follows:

SWOT	CLMP	Bias
CHRD	Cal	LEDS

Using the ENTER button, the submenu appears as shown in the following diagram. Choose the channel you wish to change by using the up ↑ and down ↓ arrow keys. The bias reading for the channel will be displayed automatically when the channel is selected.

Chan	Bias
2	0023.7

If the unit had a short circuit, the bias voltage would be <2.0V. Proper bias voltage is between 2.0V and 22V. Anything over 22V would indicate an open circuit.

13) Channel Output Measurement (CHRD on front panel):

The 482C27 is capable of digitizing the channel output and displaying it on the front panel. By moving the cursor upon the “CHRD” location, the display appears as follows:

SWOT	CLMP	Bias
CHRD	CAL	LEDS

Using the ENTER button, the submenu appears as shown in the following diagram. Choose the channel you wish to change by using the up ↑ and down ↓ arrow keys. The output reading for the channel will be displayed automatically when the channel is selected.

Chan	Output
1	005.3

14) Calibration (CAL on front panel):

The bridge calibration setting can be selected by pressing the ENTER key on the front panel when the cursor is located on the CAL option.

CHRD	CAL	LEDS
Ver?	Unit	Reset

The following submenu will appear. Choose the channel you wish to change by using the up ↑ and down ↓ arrow keys. Next, use the left / right ←→ arrow key to move the flashing cursor over to the cal mode column. To change the cal mode setting, use either the up ↑ or down ↓ arrow key to select either ‘Off’, ‘EShunt-’, ‘EShunt+’, ‘IShunt-’, ‘IShunt+’, once you have the desired setting selected hit ENTER to apply it. EShunt stands for external shunt and IShunt is internal shunt. For internal operations a resistor can be inserted in the R17 connector on the bridge input module internal to the unit.

Chan	Cal Mode
1	IShunt+

15) LED Test (LEDS on front panel):

The LED test provides a mechanism to check the functionality of the LEDS. To test them, place the cursor over the word “LEDS” on the display and press enter.

CHRD	Cal	LEDS
Ver?	Unit	Reset

This screen will be displayed:

LED	Test
CANCEL	

Use the up or down arrow keys to select 'Execute' or 'Cancel'. Both options return control to the main menu. If 'Execute' is selected then the LED's will blink 3 times and if 'Cancel' is selected then no action is taken.

16) Firmware Version (Ver? on front panel):

To determine the firmware version of the unit select the 'Ver?' menu option.

CHRD	Cal	LEDS
Ver?	Unit	Reset

A screen similar to the one shown below will be displayed:

PCB 482C27
FW v4P3.3

17) Unit Identity (Unit on front panel):

The user may change the unit ID setting by pressing the ENTER key on the front panel when the cursor is located on the 'Unit' option.

CHRD	Cal	LEDS
Ver?	Unit	Reset

The following submenu will appear. Use the up ↑ or down ↓ arrow key to change the unit ID setting to a new value. Once you have the desired setting selected hit ENTER to apply it.

Current Unit #

1

NOTE: Changing the unit ID is only necessary if the conditioner has an Ethernet port or RS-232 communication option installed and you are communicating with more than one unit. If this is the case then all units in the network **MUST** have a unique unit ID.

18) Reset to Factory Default Settings (Reset on front panel):

The 482C27 reset capability provides a mechanism to reset the unit to its factory default settings. To do this select the 'Reset' option from the menu by placing the cursor over 'Reset' and hitting enter.

CHRD	Cal	LEDS
Ver?	Unit	Reset

Pressing ENTER brings up a submenu that allows the operator to continue by selecting 'Execute' or cancel the function by selecting 'Cancel.' Both options return control to the main menu. If 'Execute' is selected then the defaults are restored.

Factory Defaults

Execute

19) Display Content Options (Disp on front panel):

The display option allows the user to choose from 3 selections of front panel content. To enter this mode place the cursor over the 'Disp' option and hit enter.

Ver?	Unit	Reset
Disp	Savs	GType

Pressing ENTER brings up a submenu that allows the operator to continue by selecting either 'Gain', 'Bias' or 'Output.' If 'Gain' is selected then each channel's current gain setting will be displayed on the 2nd line of the front panel display to the nearest integer. If the gain is greater than two significant digits then it is displayed in terms of thousands (i.e. 100 = 0.1k, 2000 = 2.0k). Additionally, directly above the gain on the 1st line of the display will be up to 3 characters representing the channels input mode; 'B' for full bridge, 'b' for ¼ or ½ bridge, 'R' for referenced single ended, 'I' for ICP®, or 'V' for voltage and 'D' for differential voltage. Next to the input mode indicator is the input filter setting; '*' for on, blank for off and '-' if the option is not installed. Next to the input filter indicator is the output filter setting indication which has the same markings as the input filter.

Display Opts

Gain

Following is what the screen will look like if the display was set to show 'Gain' and channel 1 has a gain of 2000 and is in full bridge mode with the input filter 'On' with no output filter option installed. Similarly, channel 2 has a gain of 10 and is in ICP® mode; channel 3 has a gain of 20 and is in ½ bridge mode and channel 4 has a gain of 100 and is in voltage mode.

B*-	I*-	b*-	V*-
2.0k	010	020	0.1k

The 'Bias' display option is the same as the gain option except the channels bias reading replaces the gain setting. The bias reading will be refreshed periodically.

Following is what the screen will look like if the display was set to show 'Bias.'

B*-	B*-	I*-	I*-
B15	B15	B23	B23

The 'Output' display option is the same as the bias option except the channels output is digitized and displayed. As with the bias reading it will be refreshed periodically.

Following is what the screen will look like if the display was set to show 'Output.'

B*-	B*-	B*-	I*-
+0.0	-9.9	+5.0	+1.0

NOTE: Due to the limited screen size values less than or equal to -9.9 are displayed as -9.9 and values greater than or equal 9.9 are displayed as 9.9.

20) Save current settings (Savs on front panel):

Save the current settings as the default settings the next time the conditioner is powered on.

Ver?	Unit	Reset
Disp	Savs	GType

Pressing ENTER brings up a submenu that allows the operator to continue the save settings operation by selecting 'Execute' or 'Cancel.' Both options return control to the main menu. If 'Execute' is selected then the settings on all 4 channels are saved and used as the default settings when the unit is powered on. Selecting 'Cancel' will cancel the operation.

Save Settings
EXECUTE

21) Options that are not included and/or installed

For any selected option not actually included in model 482C27, an 'option not installed' message is shown on the display. When the ENTER button is pressed, the following is shown:

Option not
installed

Reference

3-0. THEORY OF OPERATION

3-1. Sensor Excitation

ICP® refers to a voltage mode sensor that combines an integrated circuit and a piezoelectric sensing element in a single housing to provide a low impedance voltage output. The sensor is powered by a +24 VDC power supply having a typical constant current of 2 to 20 mA (current can be fixed or variable depending on the signal conditioner model).

Sensor excitation occurs as the constant current of all channels are set. Model 482C27 allows the constant current to be adjusted between 1 and 20 mA to provide the required excitation for most applications. Special situations, such as driving extra-long cables (more than 1000 ft) with high frequency or fast rise time pulses, may require increasing the drive current to 12 mA or higher.

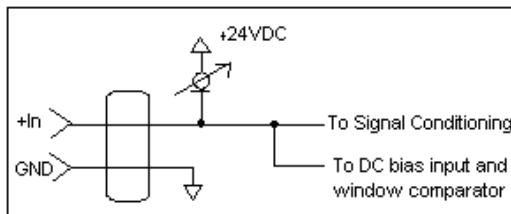

Figure 2 ICP® Sensor Excitation

When driving fast rise time pulses over long lines, system performances can be optimized by “tuning” the drive current to the line; i.e. by finding the best current setting for the particular test of physical parameters. To determine the optimal current setting, experiment with your particular test set up. To insure optimal accuracy in constant current adjustment, make sure all channels have sensors or simulated loads, similar to the one provided by model 401B04 (ICP® sensor simulator).

3-2. Input Protection

The input section has protection to limit the amplitude of the incoming signal to within +24 volts to ground. Maximum allowable input voltage without distortion is ± 10 volts, relative to the sensor bias voltage.

3-3. Input Fault Detection

Model 482C27 monitors two input fault conditions, “short” and “open,” which indicate problems with sensor input and is displayed through the front panel LEDs. Either case implies that the sensor is NOT functioning properly. An input is **shorted** when it has a ground path for the sensor excitation and **open** when the sensor fails to draw the excitation.

Two voltage comparators consist of a window comparator that has two reference voltages (V_{ref}) representing thresholds for “short” and “open.” When the sensor bias voltage (V_{bias}) exceeds the comparator range, the front panel input fault LED lights.

NOTE: Red LED implies input fault.

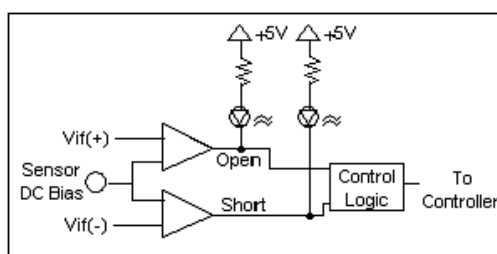

Figure 3 Input Fault Window Comparator with LED Indicator

3-4. Input Interface

The input signal conditioning for each channel provides a unity gain buffer with high-input impedance amplifiers. AC coupling eliminates the DC bias from the input signal unless DC coupling is enabled.

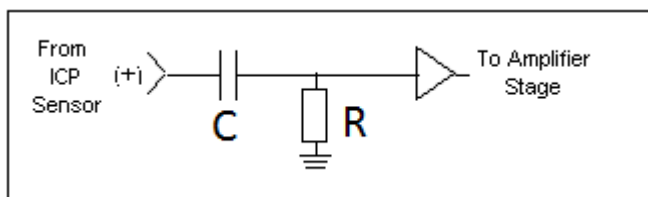

Figure 4 Input Amplifier Configuration

3-5. Normalized Output Sensitivity

The definition of normalized output sensitivity is the calculation of the individual channel’s gain, depending on the sensitivity of the sensor attached and the desired output sensitivity. This is simply a function of the desired output sensitivity (in Volts/ unit) divided by the sensor’s sensitivity.

$$\text{Gain} = 1 \text{ Volt} / \text{Sensitivity (mV/unit)}$$

Additionally, a feature to improve flexibility allows changing the output level to a value of 5 Volts/ unit instead of normalized 1 Volt/ unit. Some users request the ability calculate the gain using a known input signal along with the sensor sensitivity, and desired output level. The result of the request impacts the formula:

$$\text{Gain} = 1 \text{ Volt} / [\text{Sensitivity (mV/unit)} * \text{Full Scale Input (units)}]$$

Adding some simple error checking to insure the limits of the sensor and gain limits of the signal conditioner are not exceeded completes the normalization process.

$$\text{Gain}_{\text{normalized}} = \text{FSOT (V)} / \text{SENS} * \text{FSIN}$$

Additional Considerations:

The storage of individual channel gains is stored in non-volatile memory locations. The new variables for each channel's sensitivity, full scale output level, and full scale input are stored in non-volatile memory locations when the unit is powered down.

The error checking should provide a flag if the desired normalized output level is not feasible due to gain limitations. The gain required may be too large given the sensor sensitivity defined, or too small which implies the sensor will not be capable measure the expected value. The typical sensor will output a signal up to ± 5 Volts. The maximum swing may be used in the error checking.

3.6 Auto Scaling and Overload Detection

3-6.1 Auto Scale

To avoid overload, model 482C27 features auto scaling for automatic gain adjustment (appears as ARNG on front panel display). It first sets maximum gain on all channels, then decreases the gain setting of any channel on which an overload has occurred. Auto scale continues until there is no overload with respect to the preset overload threshold level (standard ± 10 volts) and sensed signal of the channel. Final gain and overload status interrogation is possible through the command set. The correct procedure for using the auto scale feature is as follows:

1. Excite the structure under test.
2. Enable auto scale (Auto scale ON).
3. Wait several seconds, until the unit is stabilized.
4. Disable auto scale (Auto scale OFF).
5. Read the gains of all channels.
6. Begin test run.

3-6.2 Overload

The overload feature uses the same window comparator principle previously discussed. The $+V_{\text{ref}}$ is equal to the default overload value of ± 10 volts. When the input voltage (V_{signal} of Figure 3-7.1) to the window comparator exceeds the reference voltage limits, overload has occurred, and the comparator's output, which is normally "high," becomes "low." This "low" state illuminates the overload LED and triggers the latch of overload detection circuitry. During regular measuring time, the latch holds the occurrence of overloads until the user reads its status through the computer interface.

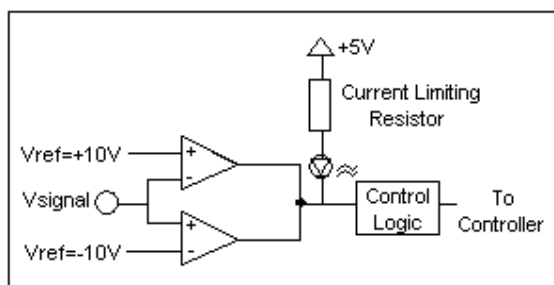

Figure 5 Auto scale/Overload Window Comparator

3-7. Connector Configuration

482C27 provides BNC jack inputs for ICP® sensors or voltage inputs and an 8 pin DIN connector NRSE, RSE, differential voltage and bridge (quarter, half, full) mode sensor inputs. The output connector is a BNC jack.

3-8. Channel Input Mode Selection

This setting allows the user to select the input mode of each channel. The selection is made through control software or the front panel keypad. The functionality of a channel in ICP® or voltage mode is identical except the bias current does not flow in voltage mode. Accordingly, when voltage mode is selected, the unit will automatically set the current to zero (0) mA for the specified channel. With no ICP® excitation present on the input connector, the channel is simply a voltage amplifier. Differential voltage, bridge (quarter, half, full), RSE and NRSE are additional input modes.

The factory default is ICP® input mode for all channels.

3-9. Bridge/Differential/RSE/NRSE Sensor Connection

The following diagram illustrates the proper connections for NRSE, RSE, differential voltage and bridge (quarter, half, full) mode sensor inputs.

NOTE: If the sense lines are not used they should be tied to the excitation lines.

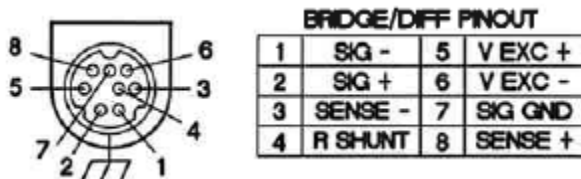

3-10. RS-232 & Ethernet connections

See section 4.0 for remote control interface details.

3-11. Non-Volatile Memory

This feature keeps the programmed configurations stored when the unit is powered down. When the unit is turned on, all programmable features (e.g., gains, filter status, input mode) active at last use are preserved. When the unit is powered down the non-volatile memory is updated with the current channel settings. The unit's non-volatile memory may be reset to the factory default settings by using the reset menu option.

3-12. Transducer Electronic Data Sheet (TEDS) Interface:

Model 482C27 has the capability of reading TEDS sensors. They attach to the input connectors the same way traditional ICP® sensors are attached. The digital control and input mode features automatically perform the TEDS read or write function.

The current TEDS function will perform a read of the "raw" TEDS data and return the 32 bytes of TEDS sensor EEPROM data and the 8 byte Application register contents, if it was programmed, and returns the data in an ASCII Hex representation. This raw data can be decoded using PCB's multi-channel signal conditioner software (PN EE75).

4-0. COMPUTER INTERFACE PROGRAMMING GUIDE

4-1. Introduction

The RS-232 interface enables model 482C27 to be remotely controlled. With this interface, the unit is able to become part of a fully automated system.

4-2. RS-232

The RS-232 provides total control of the unit except for hardware RESET. The rest of the options described previously are computer controllable.

4-3. RS-232 Host Set-Up

Before any serial interface is used to communicate with the host computer, a specific set-up must be followed. These parameters must be set for the host computer. The full list of parameters is shown below: (EOL = End of Line.)

Parameter	Setting
Transmission Rate	19,200 BPS (bits per second)
Parity	None
Number of data bits	8
Number of stop bits	1
Handshaking	None
Echo	None
Transmit EOL	Carriage Return and Line Feed, <CR><LF>
Receive EOL	Carriage Return and Line Feed, <CR><LF>

4-4. RS-232 Rear Panel Pinout Listing

Number of 9-Pin Connector	Function	Notes
1	N.C.	Not Connected
2	TXD	From 482C
3	RXD	To 482C
4	N.C.	Not Connected
5	Ground	Ground
6	N.C.	Not Connected
7	N.C.	Not Connected
8	N.C.	Not Connected
9	N.C.	Not Connected

4-5. Ethernet Communication

482C27 includes an Ethernet port for computer control. The unit's IP address must be set up before any remote communication can commence.

The steps to set the IP address of the 482C27 are as follows:

- Connect, either directly with a crossover CAT5 cable or through a hub, to a single unit. This unit is presumed to have a Unit ID of 1,
- Set the IP address using an independent utility from Lantronix called DeviceInstaller™. To download the Lantronix DeviceInstaller™ application go to:
<http://www.lantronix.com/device-networking/utilities-tools/device-installer.html>

- After the DeviceInstaller™ application is installed, run it and the following screen will appear. Click on the Search icon and the program will search for the Ethernet device internal to the 482 unit. When found, as shown below, details about the device show in the list. You can verify it is the correct unit but comparing the Hardware (MAC) Address displayed to the one listed on the side of the 482 unit.

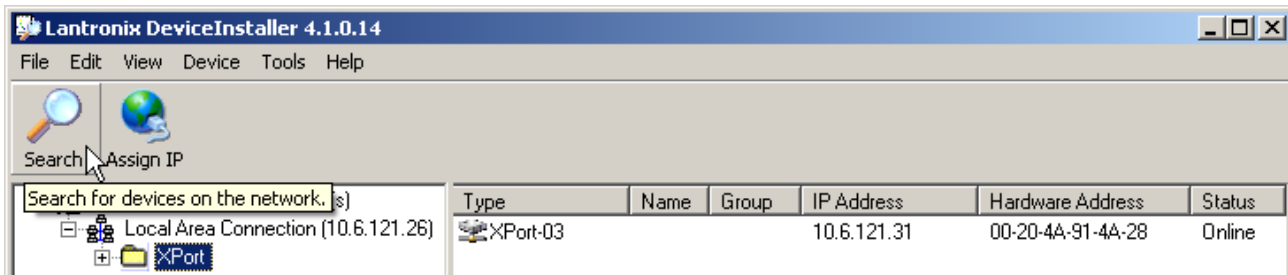

- Selecting an item from the list, shown below, highlights the item in the list and enables more icons.

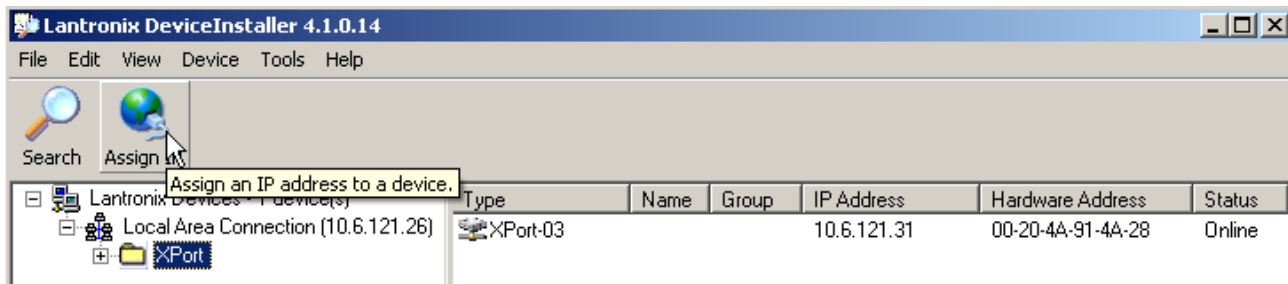

- Select **Assign IP** and the following screen will appear. Select whether you want to assign a static IP address that is appropriate for your network or have it assigned from a network server. Subsequent steps are self-explanatory.

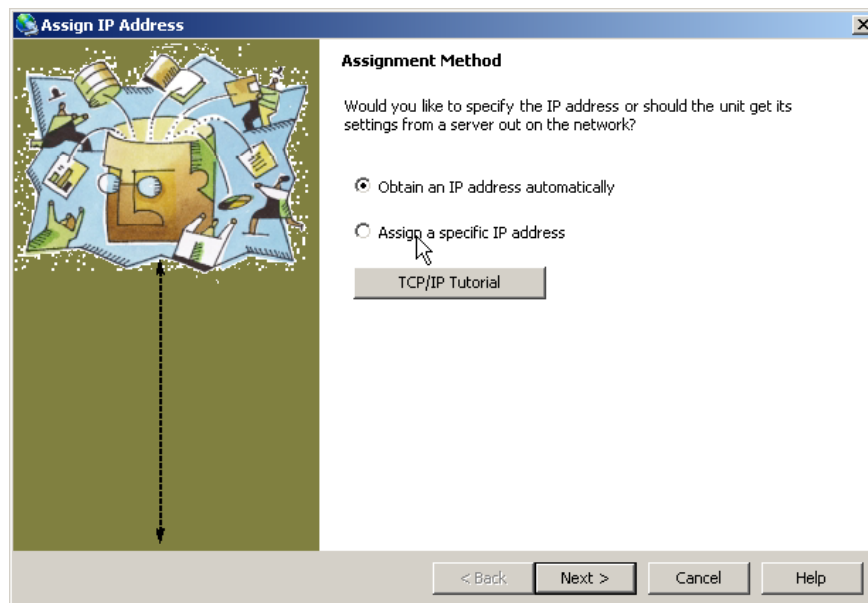

- Now you can use the assigned IP address to address the unit.

Important Note: The communication protocol requires a unit id as part of the command header. The unit id is not the IP address. To send commands to the unit via Ethernet you must address the TCP-IP packets with the proper IP address and ensure the packet payload contains the correct Unit Id in the command header.

The Lantronix device will be PCB factory set with the proper communication parameters. Some of these parameters though are not the default parameters of this device. In the screens that follow, the fields pointed to with arrows are the modified parameters. Should you need to change them or want to check them if you are experiencing communications problems the following screens will show how it is done.

Note: Port 10001 is the port selected for remote Ethernet communications.

To gain access to the Ethernet and serial parameters click on an IP address in the left pane and then on the Web Configuration tab in the right pane as shown below. Then click on the **GO** button.

This will cause the Login Dialog screen to appear (also below). No entry is required since our devices are not factory protected, click **OK**.

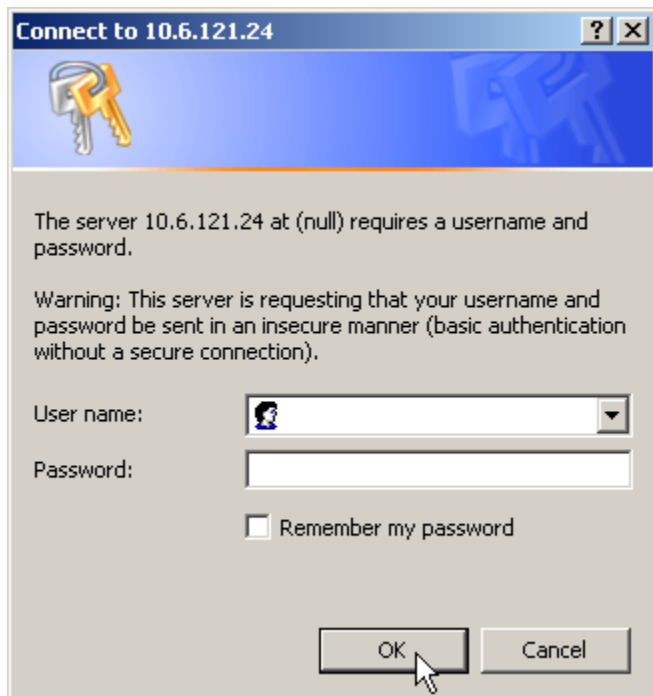
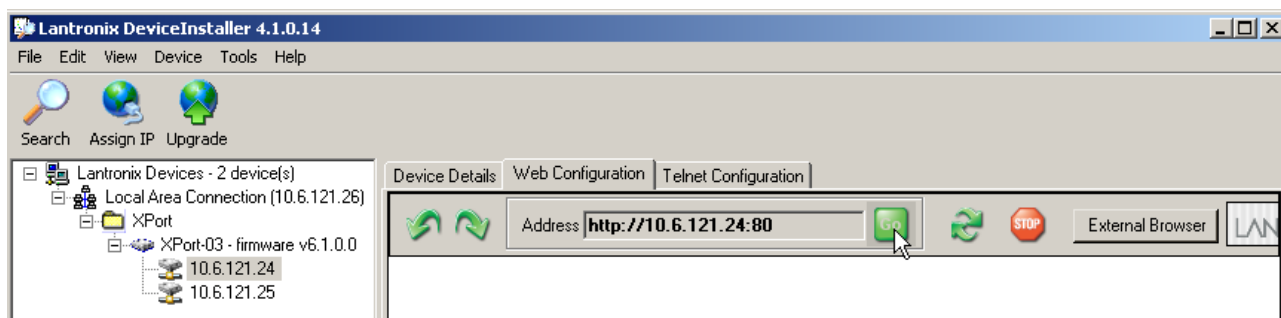

After the Login dialog the Settings pane will appear on the left as shown below, click on **Connection**. Make sure the parameters are set as shown. If you need to change the Port # do it here.

The screenshot displays the LANTRONIX web configuration interface. At the top, there are tabs for 'Device Details', 'Web Configuration', and 'Telnet Configuration'. Below the tabs, there is a navigation bar with a 'Go' button and an 'External Browser' button. The main header area shows the LANTRONIX logo, the firmware version 'V6.1.0.0', and the MAC address '00-20-4A-91-4A-28'. The left sidebar contains a menu with options: Network, Server, Serial Tunnel, Hostlist, Channel 1, Serial Settings, Connection (highlighted), Email, Trigger 1, Trigger 2, Trigger 3, Configurable Pins, Apply Settings, and Apply Factory Defaults. The main content area is titled 'Connection Settings' and is divided into several sections:

- Channel 1**
 - Connect Protocol:** Protocol: TCP
 - Connect Mode:**
 - Passive Connection: Accept Incoming: Yes
 - Active Connection: Active Connect: With Any Character
 - Start Character: 0x0D (in Hex)
 - Modem Mode: None
 - Mdm Esc Seq: Yes (selected)
 - Pass Thru: No
- Endpoint Configuration:**
 - Local Port: 10001
 - Remote Port: 0
 - Remote Host: 0.0.0.0
 - Auto increment for active connect:
- Common Options:**
 - Telnet Mode: Disable
 - Connect Response: None
 - Terminal Name:
 - Use Hostlist: No (selected)
 - LED: Blink

When finished click **OK** and then activate the **Apply Settings** option

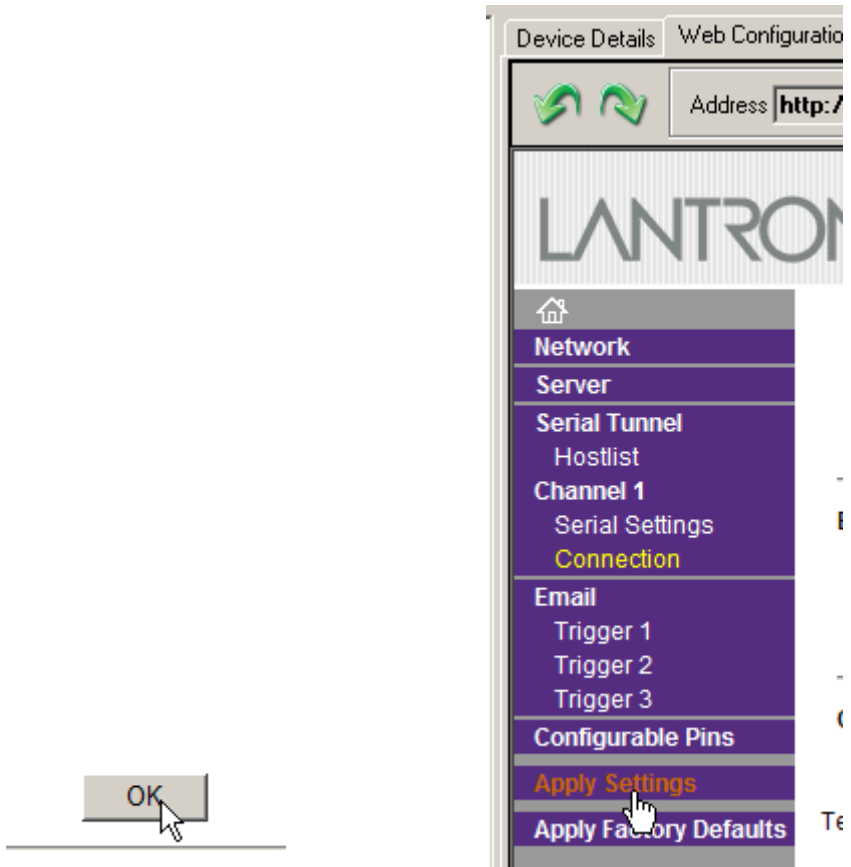

Device Details
Web Configuration
Telnet Configuration

LANTRONIX

LANTRONIX®

Firmware Version: V6.1.0.0

MAC Address: 00-20-4A-91-4A-28

- [Home](#)
- [Network](#)
- [Server](#)
- [Serial Tunnel](#)
- [Hostlist](#)
- [Channel 1](#)
- [Serial Settings](#)
- [Connection](#)
- [Email](#)
- [Trigger 1](#)
- [Trigger 2](#)
- [Trigger 3](#)
- [Configurable Pins](#)
- [Apply Settings](#)
- [Apply Factory Defaults](#)

Serial Settings

Channel 1

Disable Serial Port

Port Settings

Protocol: <input type="text" value="RS232"/>	Flow Control: <input type="text" value="None"/>
Baud Rate: <input type="text" value="19200"/>	Parity: <input type="text" value="None"/>
Data Bits: <input type="text" value="8"/>	Stop Bits: <input type="text" value="1"/>

Pack Control

Enable Packing

Idle Gap Time:

Match 2 Byte Sequence: <input checked="" type="radio"/> Yes <input checked="" type="radio"/> No	Send Frame Only: <input checked="" type="radio"/> Yes <input checked="" type="radio"/> No
Match Bytes: <input type="text" value="0x00"/> <input type="text" value="0x00"/> (Hex)	Send Trailing Bytes: <input checked="" type="radio"/> None <input type="radio"/> One <input type="radio"/> Two

Flush Mode

<p>Flush Input Buffer</p> <p>With Active Connect: <input type="radio"/> Yes <input checked="" type="radio"/> No</p> <p>With Passive Connect: <input type="radio"/> Yes <input checked="" type="radio"/> No</p> <p>At Time of Disconnect: <input type="radio"/> Yes <input checked="" type="radio"/> No</p>	<p>Flush Output Buffer</p> <p>With Active Connect: <input type="radio"/> Yes <input checked="" type="radio"/> No</p> <p>With Passive Connect: <input type="radio"/> Yes <input checked="" type="radio"/> No</p> <p>At Time of Disconnect: <input type="radio"/> Yes <input checked="" type="radio"/> No</p>
---	--

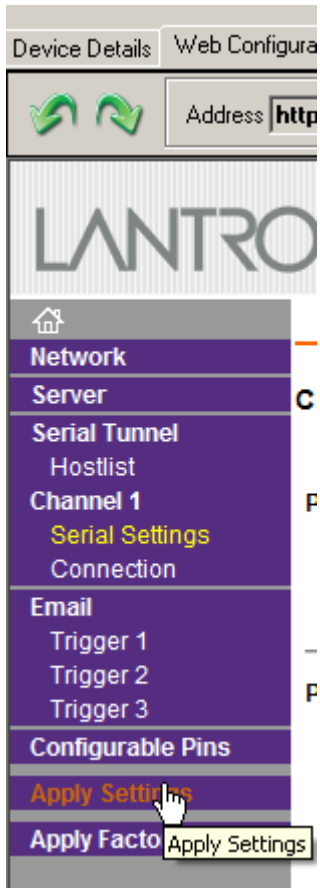

OK

4-6. Model 482C27 Communication Guidelines

1) Data transfer from the host terminal to the unit must contain an ending delimiter of <CR><LF>.

Example: <CR><LF> - Carriage Return and Line feed. (In ASCII, <CR> is 13; <LF> is 10.)

2) The number of characters for any command string, from the first character to the <CR>, may not exceed 255.

3) Status request commands, i.e., commands ending with a "?", may only be sent within one transmission.

Example: 7:0:GAIN?<CR> <LF> - Reads the gain setting of all channels.

4-7. Model 482C27 Unit Initialization Procedure

1) To begin, plug 9-pin female DSUB connector of given cable into the RS-232 port. Plug the other end of the cable into the COM port of the terminal or computer.

2) Turn on power to the unit. The display or power indicator should light up to indicate the power is on.

3) With the terminal or computer that is set up to transmit data, according to the host set-up discussed in Section 3-3, send the command:

“1:0:LEDS=0” <CR><LF>

This command flashes the front panel LEDs three times.

4-8. Command Summary

The table below is a summary of the 482C27 command set. The 482C series is highly differentiated and some commands may not be valid in all units. The 482C commands are sent and received from/to the host computer in ASCII text format.

Command	Type	Scope	Meaning
GAIN	R/W	Channel	Set or read gain
SENS	R/W	Channel	Sensor Sensitivity
FSCI	R/W	Channel	Expected Full Scale Input Value
FSCO	R/W	Channel	Full Scale Output
INPT	R/W	Channel	Input Signal Mode Selection
FLTR	R/W	Channel	Enable/disable input filters
IEXC	R/W	Channel	Read/Adjust ICP® current setting
OFLT	R/W	Channel	Enable/disable output filters
CPLG	R/W	Channel	Select AC or DC coupling
CLMP	R/W	Channel	Enable/disable Clamp
CALB	R/W	Channel	Select Internal/External Cal setting
VEXC	R/W	Channel	Read/Adjust Bridge Voltage Excitation Setting
SWOT	R/W	Unit	Switched output (4 to 1 mux)
RTED	R	Channel	Read TEDS data (DS2430A)
ALLC	R	Channel	Read majority of channel settings
RBIA	R	Unit	Measure Bias (returns all channels)
CHRD	R	Unit	Read Channel output (returns all channels)
STUS	R	Unit	input fault / overload status, for all channels
UNIT	R	Unit	Read Unit Configuration information
UNID	R/W	Unit	Set Unit ID
AZZR	FCN	Channel	AutoZero/Auto Balance

LEDS	FCN	Unit	Front panel LED test function
RSET	FCN	Unit	Restores factory default channel settings
AUTR	FCN	Channel	Enable/disable auto-scaling function
SAVS	FCN	Unit	Saves the current settings to NVRAM

Command type definitions;

- R/W – the setting can be read from or written to the unit or channel.
- R – The information can only be read from the unit or channel.
- FCN – The command invokes a function in the unit.

4-9. Command Format

The 482C27 communication protocol incorporates the concept of 'Directed' and 'Global' commands at both the Unit and Channel level with the following characteristics;

- Unit or Channel numbers =0 are global commands that affect either all units or all channels of a particular unit or both.
- Directed commands that set a unit parameter are always acknowledged (ACK) with an ASCII message that indicates '<Unit#>:<CMD>:ok' if implemented with no errors or NAK with; '<Unit#>:<CMD>:=<error#>' if an error was encountered.
- Directed commands that request a particular parameters setting (query) result in a query response being returned
- No response is ever given to a Global Unit command.
- All messages must be terminated with a <CR> (\r) and <LF> (\n) combination.

Command Format:

```
'Unit#:Ch#:Cmd[=?]{<value1 >{,< value2 >}};Ch#:Cmd[=?]{<value1>{,< value2>}}\n\r
```

- Each message must be preceded by a Unit# & Channel# (both of which could be 0)
- Messages may contain multiple commands separated by a semicolon ';'.
- The second and subsequent commands in a message shall not contain a unit number but shall contain a channel number.
- Each command in a message will evoke a response message if one is warranted (not global)
- Query's ('?') can only be directed to one unit but if the channel=0 then each channel's setting will be returned in the order 0-MAXCHANNELS separated by a ':'

Command examples:

```
1:0:GAIN=100.2\r\n          unit 1,all channels gain set to 100.2
1:1:GAIN=100.2;2:GAIN=120.3\r\n  unit 1, channel 1 gain = 100.2; channel 2 gain = 120.3
1:3:GAIN=100.2;0:FLTR=1\r\n  unit 1, channel 3 gain = 100.2; all channel's filter = ON
```

General Query Response Format

```
Unit#:Cmd:Ch#=<value>}; Ch#=<value>}...>}; Ch#=<value>}... \r\n
```

Responses to a query with a channel number=0 will return the setting of each channel in a list separated by semicolons ';'.

If the target of the query is a unit setting (ex. current excitation) then the channel number returned is the 1st channel of the board that processed the command.

4-10. Commands

GAIN

SET GAIN: This command sets the gain of a channel.

Setting:

The amplifier gain can be set directly by sending a Gain command:

1:0:GAIN=100.2\r\n (unit 1, all channels gain set to 100.2)

When a channels gain is set directly the unit will adjust the FSI parameter of the gain equation using the following equation; $FSI = (((FSO*1000)/Gain)/Sens)$ to ensure it remains valid.

Setting Response: 1:GAIN:ok

Query:

The Gain query returns all of the parameters used to determine it in a single response

Query Format: Unit#:Ch#:CMD?

Response format: Unit#:Cmd:Ch#:=Gain:SENS:FSO:FSI;

Query: 1:5:GAIN?

Response: 1:GAIN:5= 5.0: 10.0: 10.0: 200.0;

Global Query: 1:0:GAIN?

Global Response: **1:GAIN:1= 5.0: 10.0: 10.0: 200.0;2= 5.0: 10.0: 10.0: 200.0;3= 5.0: 10.0: 10.0: 200.0;4= 5.0: 10.0: 10.0: 200.0;**

SENS

The SENS command provides a mechanism to have the transducer Sensitivity influence the Gain setting of the channel. Channel Gain is calculated using the equation;

$Gain = FSO*1000/(FSI*SENS)$. If a Sensitivity is entered that caused the gain to exceed the amplifiers capability the FSI component will be adjusted to keep the equation valid.

Setting:

1:0:SENS=20.2\r\n (unit 1, all channels transducer sensitivity set to 20.2)

Setting Response: 1:SENS:ok

Query:

The Sens query returns the channels transducer sensitivity

Query Format: Unit#:Ch#:CMD?

Response format: Unit#:Cmd:Ch#:= SENS;

Query: 1:1:SENS?

Response: 1:SENS:1= 6.0;

Global Query: 1:0:SENS?

Global Response: 1:SENS:1= 6.0;2= 10.0;3= 10.0;4= 10.0;

FSCI

The FSCI command provides a scaling mechanism to automatically set the gain based on a known input level (in EU) and what output level (in Volts) you would like that Full Scale input level to be represented by. For instance 1000g's =

10Volts. These 2 values along with the transducer sensitivity set the gain. Channel Gain is calculated using the equation:
 $\text{Gain} = \text{FSO} * 1000 / (\text{FSI} * \text{SENS})$.

Setting:

1:1:FSCI=1000.000\r\n (unit 1, channel 1 FSI set to 1000.0)

Setting Response: 1:FSCI:ok

Query:

The FSCI query returns the channels Full Scale Input value in engineering units

Query Format: Unit#:Ch#:CMD?

Response format: Unit#:Cmd:Ch#:= <fsci>;

Query: 1:1: FSCI?

Response: 1:FSCI:1=1000.0;

Global Query: 1:0:FSCI?

Global Response: 1:FSCI:1=1000.0;2=1000.0;3=1000.0;4=1000.0;

FSCO

The FSCO command provides a scaling mechanism to automatically set the gain based on a known input level (in EU) and what output level (in Volts) you would like that Full Scale input level to be represented by. For instance 1000g's = 10Volts. These 2 values along with the transducer sensitivity set the gain. Channel Gain is calculated using the equation:
 $\text{Gain} = \text{FSO} * 1000 / (\text{FSI} * \text{SENS})$.

Setting:

1:1:FSCO=10.000\r\n (unit 1, channel 1 FSO set to 10.0)

Setting Response: 1:FSCO:ok

Query:

The FSCO query returns the channels Full Scale Output Value in volts

Query Format: Unit#:Ch#:CMD?

Response format: Unit#:Cmd:Ch#:= <fsci>;

Query: 1:1: FSCO?

Response: 1:FSCO:1=10.0;

Global Query: 1:0:FSCO?

Global Response: 1:FSCO:1=10.0;2=10.0;3=10.0;4=10.0;

INPT

The INPT command sets the input mode for a given channel. The mode selection is sent as an integer value. All possible input modes for the 482/483 family are listed below. The **bold** items are valid input settings for the 482C27 and 483C28.

- CHARGE 0
- **VOLTAGE 1**
- **ICP 2**
- Multi-Charge option of 10mV/pc sensitivity 3
- Multi-Charge option of 1.0mV/pc sensitivity 4
- Multi-Charge option of 0.1mV/pc sensitivity 5
- Isolated ICP 6
- Isolated Multi-Charge option of 10mV/pc sensitivity 7
- Isolated Multi-Charge option of 1.0mV/pc sensitivity 8
- Isolated Multi-Charge option of 0.1mV/pc sensitivity 9

- $\frac{1}{4}$ Bridge 10
- $\frac{1}{2}$ Bridge 11
- Full Bridge 12
- Referenced Single Ended 13
- Differential Voltage 14 (same hardware settings as full bridge)

Setting:

1:1:INPT= 12\r\n (unit 1, channel 1 input mode set to Full Bridge)

Setting Response: 1:INPT:ok

Query:

The INPT query returns the channels input mode selection

Query Format: Unit#:Ch#:CMD?

Response format: Unit#:Cmd:Ch#:= <inpt>;

Query: 1:1:INPT?

Response: 1:INPT:1= 12;

Global Query: 1:0:INPT?

Global Response: 1:INPT:1= 12.0;2= 2.0;3= 2.0;4= 2.0;

NOTE: Programmatic setting of Input mode should be followed with queries of IEXC, VEXC and GAIN since the unit will set IEXC to 0 if a Bridge input is selected and likewise will set VEXC to 0 if ICP or Voltage input is selected. Additionally, Bridge gain can be as high as 2000 but the ICP/Voltage mode maximum is 200 so switching from Bridge to ICP/Voltage will reset the Gain to the ICP maximum if the current Bridge setting is higher than the ICP maximum.

IEXC

The IEXC command sets the current excitation level for ICP mode. The current excitation value is sent as an integer value from 0 (off) to 20mA.

Setting:

1:1:IEXC= 2\r\n (unit 1, channel 1, set to 2mA)

Setting Response: 1:IEXC:ok

Query:

The IEXC query returns the units excitation value.

Query Format: Unit#:Ch#:CMD?

Response format: Unit#:Cmd:Ch#:= <IEXC>;

Query: 1:1:IEXC?

Response: 1:IEXC:1=2;

Global Query: 1:0: IEXC?

Global Response: 1:IEXC:1=2;2=4;3=4;4=4;

VEXC

The VEXC command sets the voltage excitation level for bridge and differential mode inputs.

The voltage excitation value is sent as a floating point number from 0.00 (off) to ± 12.00 Volts. If the value is sent as a negative number then the minus (-) Bridge Excitation will track the plus (+) Bridge Excitation setting. If it is sent as a Positive value then the minus (-) Bridge Excitation will be set to 0.

Setting:

1:1:VEXC= -10.00 \r\n (unit 1, channel 1, sets minus (-) Bridge Excitation and plus (+)Bridge Excitation to 10.0 volts)

1:1:VEXC= 10.0 0\r\n (unit 1, channel 1, sets minus (-) Bridge Excitation to 0 and plus (+)Bridge Excitation to 10.0 volts)

Setting Response: 1:VEXC:ok

Query:

The VEXC query returns the voltage excitation value.

Query Format: Unit#:Ch#:CMD?

Response format: Unit#:Cmd:Ch#:= <VEXC>;

Query: 1:1:VEXC?

Response: 1:VEXC:1=-10.00;

Global Query: 1:0: VEXC?

Global Response: 1:VEXC:1=-10.00;2=10.00;3=0.00;4=0.00;

FLTR

The FLTR command enables or disables the Input Filter.

The Input Filter value is sent as an integer value of either 0 -Disable or 1-Enable.

Setting:

2:1:FLTR= 1\r\n (unit 2, channel 1, Input Filter Enabled)

Setting Response: 2: FLTR:ok

Query:

The FLTR query returns the channels Input Filter selection

Query Format: Unit#:Ch#:CMD?

Response format: Unit#:Cmd:Ch#:= <0|1>;

Query: 2:1: FLTR?

Response: 2:FLTR:1=1;

Global Query: 1:0: FLTR?

Global Response: 1:FLTR:1=1;2=0;3=0;4=0;

OFLT

The OFLT command enables or disables the Output Filter.

The Output Filter value is sent as an integer value of either 0 -Disable or 1-Enable.

Setting:

2:1:OFLT= 1\r\n (unit 2, channel 1, Output Filter Enabled)

Setting Response: 2: OFLT:ok

Query:

The FLTR query returns the channels Output Filter.

Query Format: Unit#:Ch#:CMD?

Response format: Unit#:Cmd:Ch#:= <0|1>;

Query: 2:1: OFLT?

Response: 2: OFLT:1=1;

Global Query: 1:0: OFLT?

Global Response: 1: OFLT:1=1;2=0;3=0;4=0;

CLMP

The CLMP command enables or disables the Clamp feature. When Clamp is disabled the channel is 'Buffered'. The Clamp value is sent as an integer value of either 0 –Disable (buffered) or 1-Enable.

Setting:

2:1:CLMP= 1|r\n (unit 2, channel 1, Clamp Enabled)

Setting Response: 2: CLMP:ok

Query:

The CLMP query returns the channels Clamp setting.

Query Format: Unit#:Ch#:CMD?

Response format: Unit#:Cmd:Ch#:= <0|1>;

Query: 1:1:CLMP?

Response: 1:CLMP:1=0;

Global Query: 1:0:CLMP?

Global Response: 1:CLMP:1=0;2=0;3=0;4=0;

CPLG

The CPLG command sets the channel coupling to AC or DC mode. The coupling value is sent as an integer value: 0 –AC, 1-DC.

Setting:

1:1:CPLG= 1|r\n (unit 1, channel 1, DC Coupled)

Setting Response: 2: CPLG:ok

Query:

The CPLG query returns all channels coupling setting.

Query Format: Unit#:Ch#:CMD?

Response format: Unit#:Cmd:Ch#:= <0|1>;

Query: 1:1:CPLG?

Response: 1:CPLG:1=1;2=0;3=0;4=0;

Global Query: 1:0:CPLG?

Global Response: 1:CPLG:1=1;2=0;3=0;4=0;

Notes on DC Coupling

If the Coupling setting is set to DC then the Auto Zero function becomes available. Additionally, if the Input mode is set to any Bridge or differential setting then Auto Balance is also available. These functions remove the DC offset from the output.

SWOT

The Switched Output (SWOT) command selects which channel is switched to the switched output BNC for monitoring purposes as well as its normal analog output. This is a unit command so the channel designation in the command protocol is ignored

The switched output value is sent as an integer value: 0-OFF; or 1-MAX Channels to designate which channel is switched.

Setting:

1:0:SWOT= 4|r\n (unit 1, channel NA, Channel 4 is switched to the switched output BNC)

Setting Response: 1: SWOT:ok

Query:

The SWOT query returns all channels coupling setting.

Query Format: Unit#:Ch#:CMD?

Response format: Unit#:Cmd:Ch#:= <channel # or 0=OFF>;

Query: 1:1:SWOT?

Response: 1:SWOT:1=4;

CALB

The Calibration mode (CALB) command selects the calibration setting. For the 482C27 the options are OFF, Internal Shunt + or Internal Shunt -. For other models External Cal and Internal Cal using internally generated 100Hz or 1kHz sine wave signals are available.

The CALB value is sent as an integer value of either 0 –Disable, 1-1000 Hz Enable, 2-100 Hz Enable, 3-External Cal, 4 -Internal Shunt +, 5 – Internal Shunt -

Setting:

1:1: CALB= 4|r\n (unit 1, channel 1, Internal Shunt Cal +)

Setting Response: 1:CALB:ok

Query:

The CALB query returns the channels calibration setting.

Query Format: Unit#:Ch#:CMD?

Response format: Unit#:Cmd:Ch#:= <0|1>;

Query: 1:1: CALB?

Response: 1: CALB:1=4;

Global Query: 1:0:CALB?

Global Response: 1:CALB:1=4;2=0;3=0;4=0;

RTED

The Read TEDS (RTED) command returns the TEDS information that is stored in the sensor or other, TEDS capable, in-line module attached to a selected channel. The 482x devices are 1451.4 compliant in that they will read the DS2430A Application Register Status to see if it indicates the 64 bit Application Register has data in it. If so it will read the Application register contents and return it followed by the contents of the TEDS EEPROM.

NOTE: The 1st byte of the DS2430A EEPROM data should contain the checksum of both the Application Register contents and the EEPROM contents if the TEDS is 1451.4 compliant. No attempt is made to validate or interpret the TEDS data.

Setting:

N/A – Command is Read only

Query:

The RTED query returns the TEDS data associated with the specified channel. This command must be directed to a specific channel. It will return an indicator that specifies if the DS2430A Application register has been

used to store the basic TEDS data and up to 40 bytes in ASCII Hex format (8 bytes of Application register content if it was burned and 32 bytes of the EEPROM content).

Query Format: Unit#:Ch#:CMD?

Response format: Unit#:Cmd:Ch#= <APP Reg Status>:<APP Reg Contents (8 bytes if APP Reg Status=1)><DS2430A EEPROM Contents (32 bytes)>

Where: APP Reg Status=1 if the APP Register had data or 0 if it did not

Query: 1:1:RTED?

Response: (for TEDS chip (DS3430A) on channel 1 with valid app register data)

1:RTED:1=1:168010a00975000012648016a88ae8e112801f2000f60ec4046dd18737f3206a380555e765390800

ALLC

The ALLC command is used to read several channel settings at once.

Setting:

N/A – Command is Read only

Query:

This command must be a directed command use of the global channel indicator is not allowed.

Query Format: Unit#:Ch#:CMD?

Response format: Unit#:Cmd:Ch#:= GAIN:<Gain value>; SENS:< SENS value>; FSCI:< FSCI value>; FSCO:< FSCO value>; INPT:< INPT value>; FLTR:< FLTR value>; IEXC:< IEXC value>; OFLT:< OFLT value>; CPLG <CPLG value>; CLMP:< CLMP value>; CALB:< CALB value>; VEXC:< VEXC value>; SWOT:< SWOT value>;

Query: 1:1:ALLC??

Response: 1:ALLC:1=GAIN: 2.7;SENS: 10.0;FSCI: 187.7;FSCO: 5.0;INPT: 2.0;FLTR:0;IEXC :2;OFLT:0;CPLG:1;CLMP:0;CALB:0;VEXC: 0.0;SWOT:0;

RBIA

The RBIA command is used to read all channels Bias Levels.

Setting:

N/A – Command is Read only

Query:

This command is a global command and will return all channel bias readings regardless of the channel id in the command.

Query Format: Unit#:Ch#:RBIA?

Response format: Unit#:Cmd:Ch#:=CH1 bias;... CHn#:=CHn bias;

Query: 1:1:RBIA?

Query Response: 1:RBIA:1= 12.5;2= 25.5;3= 25.5;4= 25.5;

CHRD

The CHRD command is used to read all channels output levels.

Setting:

N/A – Command is Read only

Query:

This command is a global command and will return all channel A/D readings regardless of the channel id in the command.

Query Format: Unit#:Ch#:CHRD?

Response format: Unit#:Cmd:Ch#:=CH1 A/D;... CHn#:=CHn A/D;

Query: 1:0:CHRD?

Query Response 1:CHRD:1= 4.049;2=5.338;3=2.137;4=10.373;

STUS

The STUS command is used to read the unit and all channel status indicators.

Setting:

N/A – Command is Read only

Query:

This command is a global command and will return all channel bias readings regardless of the channel id in the command.

Query Format: Unit#:Ch#:STUS?

Response format: Unit#:Cmd:Ch#:<unit status bit map>;<CH1 status bit map>;...;<CHn status bit map>;

Query: 1:1:STUS?

Query Response: 1:STUS:1:0;1;5;5;5;

Where :

Unit Bit 0 = 1= BAD EEPROM read for channel settings on power up

Unit Bit 1 = 1= BAD EEPROM read for Unit options on power up

Unit Bit 2 = 1= BAD EEPROM read for cal factors on power up

For Unit bit map 0=no errors

Channel Bit 0= Short input fault (0=Fault; 1 = no fault)

Channel Bit 1= Open input fault (0=Fault; 1 = no fault)

Channel Bit 2= Overload condition (0=Overload; 1 = no Overload)

For channel bit map 7=no errors

UNIT

Query:

The UNIT query returns the unit configuration information which includes the installed options, unit number, Model id and starting channel number

Query Format: Unit#:Ch#:CMD?

Response format: Unit#:Cmd:Model string:Firmware Ver string: Serial Number:Cal Date:Filter Corner: Unit#:#channels:Starting Ch#: Gain Option byte, Input Option Byte, Filter option byte,Misc1 option byte,Misc2 option byte<cr><lf>

Query: 1:1:UNIT?

Response: 1:UNIT:482C27\s\s\s\s\s\s\s\s\s\s:FW\sVer\s1.0:12345:09-27-2006:10.000:1:4:1:16,37,1,143,0\r\n

Model & Firmware version strings are self-explanatory. Following are:
Serial Number (U16): Cal Date (10 character string): Filter corner (kHz)

Unit Id: Number of Channels: Starting Channel Number
 Followed by the 5 option bytes:

Gain Options

OPT_GAIN_x1	0x01	Fixed x1
OPT_GAIN_x5	0x02	Fixed x5
OPT_GAIN_x10	0x04	Fixed x10
OPT_GAIN_VAR	0x08	Variable Fixed (x1,x10,x100)
OPT_GAIN_INC	0x10	incremental .1-200
OPT_GAIN_FINE2h	0x20	Fine Gain .0025-200
OPT_GAIN_FINE1k	0x40	Fine Gain .0025-1000

Input Options

OPT_INP_ALLCHG	0x01	All charge
OPT_INP_ICPVOLTCHG	0x02	ICP VOLT CHG
OPT_INP_ICPVOLT	0x04	ICP VOLT
OPT_INP_INTCAL	0x08	Internal Cal
OPT_INP_EXTCAL	0x10	External Cal
OPT_INP_ISOLATION	0x20	Isolation
OPT_INP_BRIDGE	0x40	Bridge Modules Installed

Filter Options

OPT_FILTER_IN	0x01	Input filter (time constant)
OPT_FILTER_OUT	0x02	Output filter
OPT_FILTER_FIXLP	0x04	Fixed LP filter
OPT_FILTER_PGMELP	0x08	Prgm LP Elliptical filter
OPT_FILTER_PGMBTR	0x10	Prgm LP Butterworth filter

Miscellaneous Options

OPT_MISC_COUPLING	0x01	AC/DC coupling
OPT_MISC_CLAMP	0x02	Clamp
OPT_MISC_TEDS	0x04	TEDS
OPT_MISC_IEXC	0x08	current excitation
OPT_MISC_SINTG	0x10	Single Integration
OPT_MISC_DINTG	0x20	Double Integration
OPT_MISC_MUX	0x40	Mux /Switch-out
OPT_MISC_DISPLAY	0x80	FP Display

Miscellaneous Options 2

OPT_MISC2_OLDISO	0x01	Reserved
OPT_MISC2_A2D	0x02	Digital Output available

UNID

The UNID command is used to set the units ID number. The Unit Id number is critical to remote communications since it indicates which commands a unit should accept and respond to. Units are typically shipped with a unit id of 1. If more than one unit is in the system and they will be communicated with remotely the user must set a unique id in each unit. This can be done through the front panel interface, if one exists, or by connecting to each unit individually and sending this command.

Setting:

1:1:UNID= 2\r\n (unit 1, channel 1, New ID=2)

Setting Response: 2:UNID:ok

NOTE: The new Unit Id becomes effective immediately

Query:

This command can be sent as a query but its usefulness is marginal being as it is a directed command and as such it is necessary to include the Unit Id in the command and the response will simply validate the commands unit id parameter.

Query Format: Unit#:Ch#:UNID?

Response format: Unit#:Cmd:Ch#:=unit id

Query: 2:1:UNID?

Query Response: 2:UNID:1=2;

AZZR

The AZZR command is used to Auto Zero (input shorted) or Auto Balance (input connected) a channel that is DC coupled. This command invokes a function and therefore has no query capability. The function parameters are: 1=Auto Zero, 2=Auto Balance. (Auto Balance is only valid if the channel has a bridge input type selected)

Setting:

2:1:AZZR= 1|r|n (unit 2, channel 1, Auto Zero)

Setting Response: 2:AZZR:ok

Query:

N/A

Note: the following error codes could be reported by the auto zero/balance function;

- -11 Bridge DC Offset ERR - Illegal Setting
- -12 Bridge DC Offset ERR - Too Many iterations
- -13 ICP DC Offset ERR - Bad RDG
- -14 ICP DC Offset ERR - Too Many iterations
- -15 Balance Request, channel not in Bridge mode - Illegal Setting
- -16 Zero Request, channel not in Bridge mode or ICP/volt - Illegal Setting
- -17 Current Excitation Setting not allowed in Bridge input modes – Illegal Setting
- -18 Voltage Excitation Setting not allowed in non-Bridge input modes – Illegal Setting

LEDS

The LEDS command is used to test the LED functionality of the front panel. When sent as a command the LED's on the front panel will flash 3 times. This command invokes a function and therefore has no query capability.

Setting:

2:1:LEDS= 0|r|n (unit 2, channel 1, Any value)

Setting Response: 2:LEDS:ok

Query:

N/A

RSET

The RSET command is used to restore the factory default channel settings for every channel in the specified unit. This command invokes a function and therefore has no query capability.

Setting:

2:0:RSET = 1|r|n (unit 2, channel 0, RSET cmd, 1(TRUE))

Setting Response: 2:RSET:ok

Query:

N/A

The factory Defaults are:

- Gain = 1.0
- Sensitivity = 10.0
- Full Scale Input = 1000.0
- Full Scale Output = 10.0
- Input Mode = ICP
- Input Filter = Disabled
- Current Excitation = 4.0mA
- Voltage Excitation = 0 volts
- Output Filter = Disabled
- Coupling = AC
- Clam p= OFF
- Calibration = OFF
- Switched Output = OFF
- Gain Type = Gain

AUTR

The AUTR command invokes the Auto-Range function. This function (also referred to as auto-scale) provides an automatic scaling of the output signal by adjusting the programmable gain to give .8 of the Full Scale Output setting. The signals are checked internally using the onboard channel output A/D. Possible settings are: **0=off, 1-on, 2=immediate**. The Immediate option causes the auto scale function to execute one time and then turns off the function automatically. When Auto scale is 'ON' the unit will continue to invoke the function, adjusting the gain for the current input level, until the function is turned OFF with a subsequent command.

Setting:

2:1:AUTR =1|r|n (unit 2, channel 1, Auto Scaling ON)

Setting Response: 2:AUTR:ok

Query:

Query Format: Unit#:Ch#: AUTR?

Response format: Unit#:Cmd:Ch#:=current state (0=off,1-on,2=immediate)

Query: 2:1:AUTR?

Query Response: 2:AUTR:1=0;

SAVS

The SAVS command is used to store the current channel setting as the default settings that will be restored on power up. This command is available primarily for units without a front panel display and keypad. Units with a soft key power button will save the channel settings automatically at power down because the units firmware handles the power button processing. Units without the soft key have power removed abruptly and don't not have the opportunity to save the settings automatically. This command invokes a function and therefore has no query capability.

Setting:

2:1:SAVS = 1|r|n(unit 2, channel 1, Any value)

Setting Response: 2:SAVS:ok

Query:

N/A

Communication Responses

Typically the unit will return **<Unit>:<Cmd String>:OK** when the command is successful. Errors are indicated with negative numbers. The unit may return one of the following:

<Unit>:<Cmd String>:OK<CR> <LF>

Represents that the last command was entered in the correct format and was performed properly.

<Unit>:<Cmd String>:-1<CR> <LF>

Option Error. The unit is not equipped with the option necessary to implement the command sent

<Unit>:<Cmd String>:-2<CR> <LF>

Channel Error. The channel number in the command is invalid.

<Unit>:<Cmd String>:-3<CR> <LF>

Command Error. The command is not recognized.

<Unit>:<Cmd String>:-4<CR> <LF>

Unit Error. The unit number in the command is invalid.

<Unit>:<Cmd String>:-5<CR> <LF>

Unit Error. The function invoked by the command encountered an error or a query only command (ex. RBIA) was sent as a setting.

<Unit>:<Cmd String>:-6<CR> <LF>

Command Parameter Error. A channel setting parameter was found to be out of range.

5-0. Wiring Information

Differential voltage and full bridge mode can be used to accept a differential voltage signal from any source. Two additional modes, RSE (referenced single ended) and NRSE (non-referenced single ended) accommodate voltage inputs, such as 3 wire sensors with a power connection, ground connection and voltage signal output. In all cases the SENSE and EXC lines must be connected. The figures below illustrate the connections in each of these modes.

NOTE: The shell of the DIN connector is connected as shown to earth ground internally.

5-1. Differential Voltage & Full Bridge Mode

Figure 7 and Figure 8 show how the unit should be wired to a differential voltage or full bridge sensor. For optimum performance, the V EXC and SENSE lines should be connected at the sensor as shown in Figure 7 below.

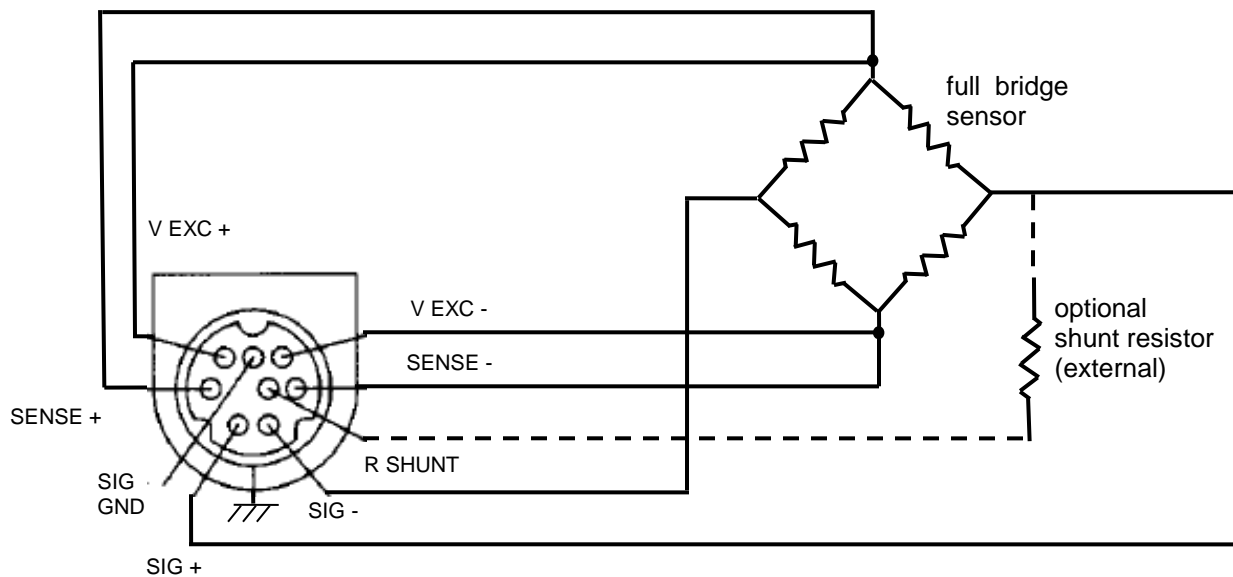
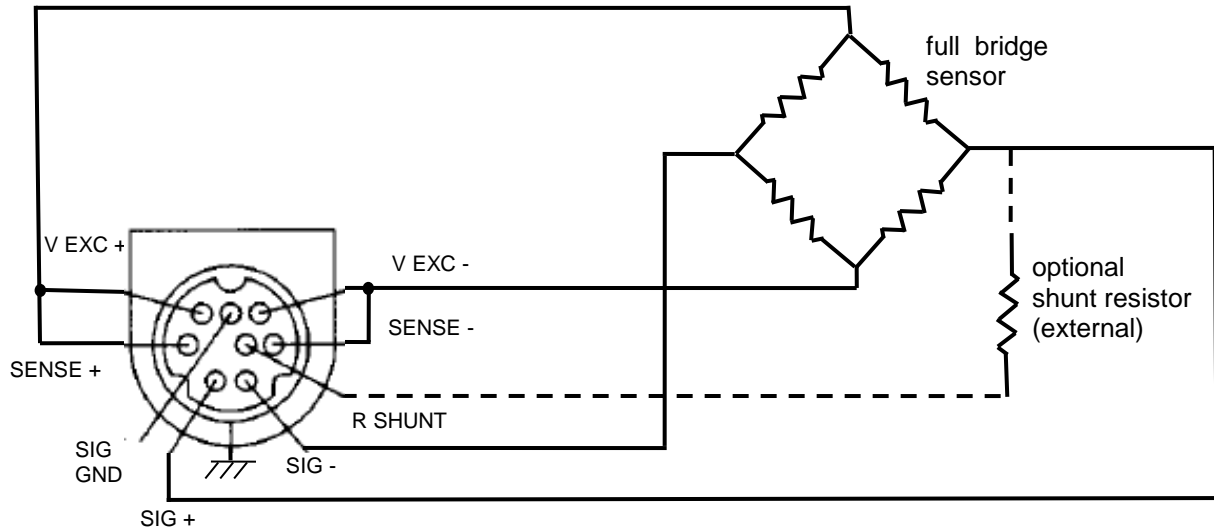
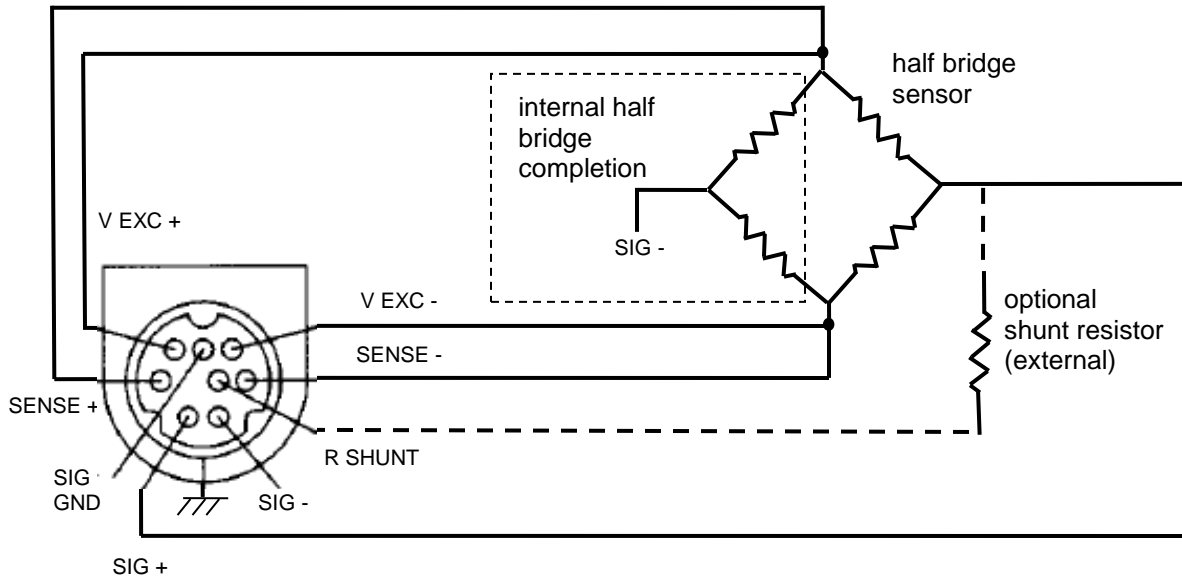

Figure 6 Differential Voltage/Full Bridge Type Sensor Connections
(sense leads wired for optimum performance)



**Figure 7 Alternate Connections for Differential Voltage/Full Bridge Type Sensors
(sense leads connected at the signal conditioner)**

5-2. Half Bridge Mode



**Figure 8 Recommended Connections for Half Bridge Type Sensors
(sense leads wired for optimum performance)**

5-3. Quarter Bridge Mode

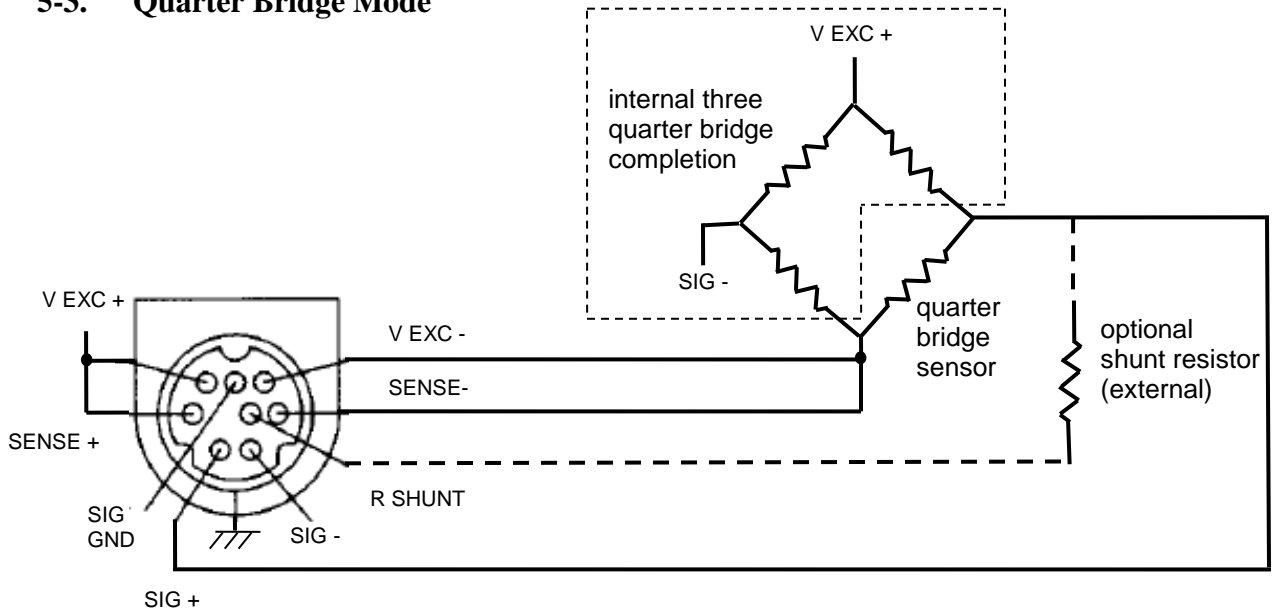
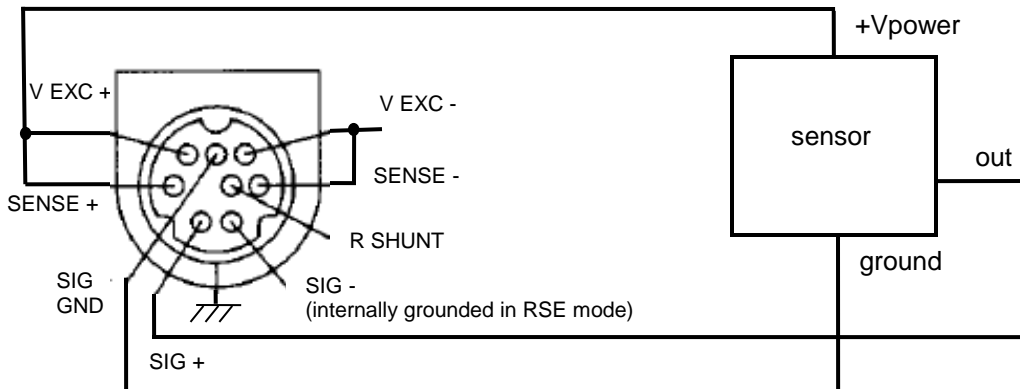

**Figure 9 Recommended Connections for Quarter Bridge Type Sensors
(sense lead wired for optimum performance)**

5-4. RSE / NRSE Mode for 3 Wire Sensors

Three wire sensors having a power connection, a ground connection, and a voltage output may be connected as shown in Figure 11 below. The channel should be set to RSE mode which internally grounds the SIG- input. The voltage output from the sensor (or other source) may then be applied to the SIG+ (non-inverting) input. Set V EXC to unipolar at a voltage appropriate to power the sensor, and ensure that the V EXC lines are tied to the respective SENSE lines.

If an inversion is desired, use NRSE mode which internally connects SIG+ to ground. The voltage output from the sensor may then be applied to the SIG- (inverting) input.



**Figure 10 Recommended Connections for 3 Wire Type Sensor
(channel in RSE mode)**

5-5. Connection of Triaxial Sensors

Many triaxial resistive bridge sensors have shared excitation lines, and other types of sensors may have shared power and ground lines. The V EXC, SENSE, or SIG GND lines for each channel may be tied together, however it is recommended that when doing so the excitation settings for each channel be identical for optimum performance.

Appendix A: Differential MEMS Sensor Setup Guide for Model 482C27

In order to setup model 482C27 for use with differential MEMS sensors (such as PCB® model series 3501, 3503, 3641, 3651, 3741 and 3991) apply the following settings through the front panel control keypad:

- 1) **Input Mode Select (INPT on front panel):** Set sensor input type to Differential Voltage.
- 2) **Gain Type (GType on front panel):** Set the gain type to GAIN.
- 3) **Gain (GAIN on front panel):** Set signal conditioner channel gain to 1 on all channels connected to a MEMS sensor.
- 4) **Coupling (ACDC on front panel):** Set signal conditioner input coupling to DC.
- 5) **Voltage Excitation (EXCv on front panel):** Set the excitation voltage to sensor to 10.00 and unipolar (UNI).

All other settings can be ignored. With these settings, the output scale factor on each channel will be equal to the calibrated sensor sensitivity, which can be read directly from the calibration certificate for any particular sensor. Other scale factors can be achieved by adjusting the gain directly.

If using MCSC Control Software for setup, the recommended settings are shown in Figure A1 below.

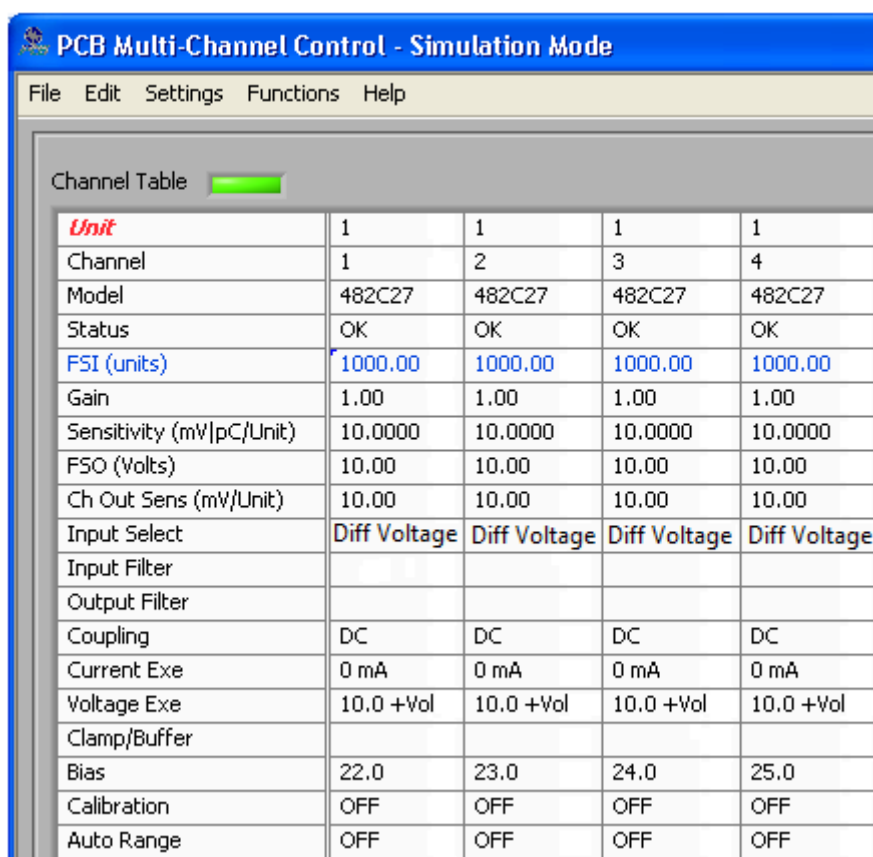

The screenshot shows the 'Channel Table' in the PCB Multi-Channel Control - Simulation Mode software. The table lists settings for four channels (1, 2, 3, and 4). The 'FSI (units)' row is highlighted in blue. The 'Input Select' row is set to 'Diff Voltage' for all channels. The 'Voltage Exe' row is set to '10.0 +Vol' for all channels.

<i>Unit</i>	1	1	1	1
Channel	1	2	3	4
Model	482C27	482C27	482C27	482C27
Status	OK	OK	OK	OK
FSI (units)	1000.00	1000.00	1000.00	1000.00
Gain	1.00	1.00	1.00	1.00
Sensitivity (mV pC/Unit)	10.0000	10.0000	10.0000	10.0000
F50 (Volts)	10.00	10.00	10.00	10.00
Ch Out Sens (mV/Unit)	10.00	10.00	10.00	10.00
Input Select	Diff Voltage	Diff Voltage	Diff Voltage	Diff Voltage
Input Filter				
Output Filter				
Coupling	DC	DC	DC	DC
Current Exe	0 mA	0 mA	0 mA	0 mA
Voltage Exe	10.0 +Vol	10.0 +Vol	10.0 +Vol	10.0 +Vol
Clamp/Buffer				
Bias	22.0	23.0	24.0	25.0
Calibration	OFF	OFF	OFF	OFF
Auto Range	OFF	OFF	OFF	OFF

Figure A1 Settings for Differential MEMS Sensors

Appendix B: Single Ended MEMS Sensor Setup Guide for Model 482C27

In order to setup model 482C27 for use with single-ended MEMS sensors (such as PCB® model series 3711 and 3713) apply the following settings through the front panel control keypad:

- 1) **Input Mode Select (INPT on front panel):** Set sensor input type to RSE.
- 2) **Gain Type (GType on front panel):** Set the gain type to GAIN.
- 3) **Gain (GAIN on front panel):** Set signal conditioner channel gain to 1 on all channels connected to a MEMS sensor.
- 4) **Coupling (ACDC on front panel):** Set signal conditioner input coupling to DC.
- 5) **Voltage Excitation (EXCv on front panel):** Set the excitation voltage to sensor to 10.00 and unipolar (UNI).

All other settings can be ignored. With these settings, the output scale factor on each channel will be equal to the calibrated sensor sensitivity, which can be read directly from the calibration certificate for any particular sensor. Other scale factors can be achieved by adjusting the gain directly.

If using MCSC Control Software for setup, the recommended settings are shown in Figure A2 below.

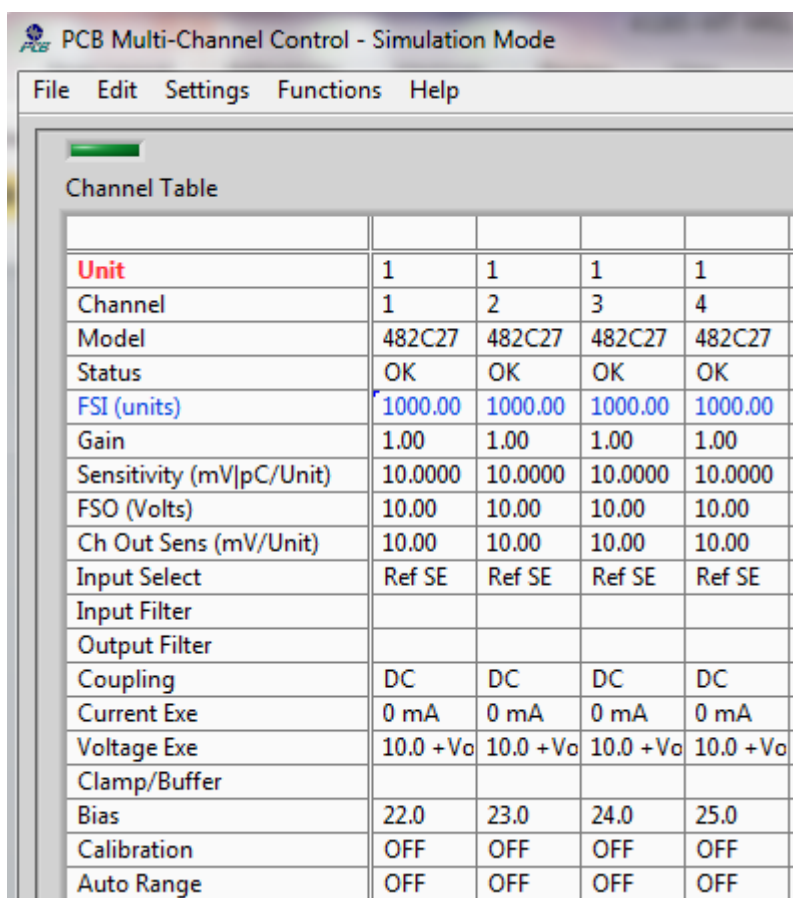

	1	2	3	4
Unit	1	1	1	1
Channel	1	2	3	4
Model	482C27	482C27	482C27	482C27
Status	OK	OK	OK	OK
FSI (units)	1000.00	1000.00	1000.00	1000.00
Gain	1.00	1.00	1.00	1.00
Sensitivity (mV pC/Unit)	10.0000	10.0000	10.0000	10.0000
FSO (Volts)	10.00	10.00	10.00	10.00
Ch Out Sens (mV/Unit)	10.00	10.00	10.00	10.00
Input Select	Ref SE	Ref SE	Ref SE	Ref SE
Input Filter				
Output Filter				
Coupling	DC	DC	DC	DC
Current Exe	0 mA	0 mA	0 mA	0 mA
Voltage Exe	10.0 +Vo	10.0 +Vo	10.0 +Vo	10.0 +Vo
Clamp/Buffer				
Bias	22.0	23.0	24.0	25.0
Calibration	OFF	OFF	OFF	OFF
Auto Range	OFF	OFF	OFF	OFF

Figure A2 Settings for Single Ended MEMS Sensors

Performance	ENGLISH	SI	
Channels	4	4	
Sensor Input Type(s)	ICP®, Voltage, Bridge/Differential	ICP®, Voltage, Bridge/Differential	
Voltage Gain(ICP/Voltage Mode)	0.1 to 200	0.1 to 200	
Voltage Gain(Bridge/Differential Mode)	0.1 to 2000	0.1 to 2000	
Accuracy(Gain, x0.1 to x0.4)	± 5 %	± 5 %	
Accuracy(Gain, x0.5 to x0.99)	± 1 %	± 1 %	
Accuracy(Gain, x1.0 to x2000)	± 0.5 %	± 0.5 %	
Accuracy(Excitation)	± 1 %	± 1 %	
Input Range(Differential)	± 0 to 10 V	± 0 to 10 V	
Output Range(Minimum)	± 10 V	± 10 V	
Frequency Range(-5 %)(<100 Hz)	0.05 to 100,000 Hz	0.05 to 100,000 Hz	[5]
Frequency Range(-5 %)(≥ 100 Hz)	0.05 to 50,000 Hz	0.05 to 50,000 Hz	[5]
Phase Response(at 1 kHz)	± 1 °	± 1 °	
Cross Talk(maximum @ 10kHz)	-72 dB	-72 dB	
Calibration(Shunt)	Internal/External	Internal/External	
TEDS Sensor Support	Yes	Yes	
Fault/Bias Monitor/Meter(LED)	Open/Short/Overload	Open/Short/Overload	
Control Interface			
Human Interface	Keypad	Keypad	
Display	2 rows, 16 columns	2 rows, 16 columns	
Digital Control Interface	RS-232	RS-232	
Digital Control: Data Rate	19,200 bps	19,200 bps	
Digital Control: Start, Data, Stop, Parity	1, 8, 1, No	1, 8, 1, No	
Digital Control: Handshaking	RTS/CTS	RTS/CTS	
Digital Control: Cable Length(Maximum)	50 ft	50 ft	
Digital Control Interface	Ethernet	Ethernet	
Environmental			
Temperature Range(Operating)	+32 to +120 °F	0 to +50 °C	
Electrical			
Power Required(for supplied AC power adaptor)	AC Power	AC Power	
AC Power(50 to 60 Hz)	100 to 240 VAC	100 to 240 VAC	
AC Power	1.6 amps	1.6 amps	
Excitation Voltage(To Sensor)	>+24 VDC	>+24 VDC	
Excitation Voltage(Positive)	+0 to 12 V	+0 to 12 V	[1]
Excitation Voltage(Negative)	-0 to 12 V	-0 to 12 V	[1][2]
Input Imbalance Adjustment(Maximum, Gain <10)	± 2 V	± 2 V	
Input Imbalance Adjustment(Maximum, Gain ≥ 10)	± 0.2 V	± 0.2 V	
Common Mode Voltage(Maximum)	± 10 V	± 10 V	
DC Offset(Stability, Maximum RTI)	5 μ V/°C	5 μ V/°C	
DC Offset(AC Coupled)	≤ 50 mV	≤ 50 mV	
DC Offset(DC Coupled, Gain <100)	<10 mV	<10 mV	
DC Offset(DC Coupled, Gain ≥ 100)	<20 mV	<20 mV	
DC Power	+9 to 18 VDC	+9 to 18 VDC	
DC Power	≤ 2.5 amps	≤ 2.5 amps	
Current Output(Excitation, Maximum)	30 mA	30 mA	
Constant Current Excitation(To Sensor)	0 to 20 mA	0 to 20 mA	
Output Impedance	≤ 50 Ohm	≤ 50 Ohm	
Impedance(Input)	>1 MOhm	>1 MOhm	
Overload Threshold(± 0.2 Vpk)	± 10 Vpk	± 10 Vpk	
Broadband Electrical Noise(1 to 10,000 Hz)(Gain x1)	50 μ V rms	50 μ V rms	[3]
Spectral Noise(1 Hz)(Gain x1)	6.0 μ V/√Hz	6.0 μ V/√Hz	[3]
Spectral Noise(10 Hz)(Gain x1)	1.5 μ V/√Hz	1.5 μ V/√Hz	[3]
Spectral Noise(100 Hz)(Gain x1)	1.0 μ V/√Hz	1.0 μ V/√Hz	[3]
Spectral Noise(1 kHz)(Gain x1)	1.0 μ V/√Hz	1.0 μ V/√Hz	[3]
Spectral Noise(10 kHz)(Gain x1)	1.0 μ V/√Hz	1.0 μ V/√Hz	[3]
Broadband Electrical Noise(1 to 10,000 Hz)(Gain x10)	75 μ V rms	75 μ V rms	[3]
Spectral Noise(1 Hz)(Gain x10)	20 μ V/√Hz	20 μ V/√Hz	[3]
Spectral Noise(10 Hz)(Gain x10)	1.5 μ V/√Hz	1.5 μ V/√Hz	[3]
Spectral Noise(100 Hz)(Gain x10)	1.0 μ V/√Hz	1.0 μ V/√Hz	[3]
Spectral Noise(1 kHz)(Gain x10)	1.0 μ V/√Hz	1.0 μ V/√Hz	[3]
Spectral Noise(10 kHz)(Gain x10)	1.0 μ V/√Hz	1.0 μ V/√Hz	[3]
Broadband Electrical Noise(1 to 10,000 Hz)(Gain x100)	350 μ V rms	350 μ V rms	[3]
Spectral Noise(1 Hz)(Gain x100)	140.0 μ V/√Hz	140.0 μ V/√Hz	[3]
Spectral Noise(10 Hz)(Gain x100)	14.0 μ V/√Hz	14.0 μ V/√Hz	[3]
Spectral Noise(100 Hz)(Gain x100)	8.0 μ V/√Hz	8.0 μ V/√Hz	[3]
Spectral Noise(1 kHz)(Gain x100)	4.0 μ V/√Hz	4.0 μ V/√Hz	[3]
Spectral Noise(10 kHz)(Gain x100)	4.0 μ V/√Hz	4.0 μ V/√Hz	[3]
Broadband Electrical Noise(1 to 10,000 Hz)(Gain x1000)	3000 μ V/rms	3000 μ V/rms	[4]
Physical			
Electrical Connector(ICP® Sensor Input)	BNC Jack	BNC Jack	
Electrical Connector(Bridge/Differential)	8-socket mini DIN	8-socket mini DIN	
Electrical Connector(Output)	BNC Jack	BNC Jack	
Electrical Connector(DC Power Input)	6-socket mini DIN	6-socket mini DIN	
Electrical Connector(RS-232 Digital Control)	DB-9 Connector	DB-9 Connector	
Electrical Connector(Ethernet)	RJ45	RJ45	
Size (Height x Width x Depth)	3.20 in x 8.00 in x 5.90 in	8.10 cm x 20.0 cm x 15 cm	
Weight	2.50 lb	1134 gm	

OPTIONAL VERSIONS

Optional versions have identical specifications and accessories as listed for the standard model except where noted below. More than one option may be used.

NOTES:

[1] Adjustable in 0.1V steps.
 [2] Negative excitation can be set to 0V or to track the positive excitation voltage.
 [3] Typical, AC Coupled.
 [4] Bridge/Differential Mode, DC Coupled with 350 ohm bridge
 [5] AC coupled mode (low frequency response is 0Hz in DC Coupled mode.)
 [6] See PCB Declaration of Conformance PS023 for details.

SUPPLIED ACCESSORIES:

Model 017AXX Power Cord (1)
 Model 100-7103-50 (02711) Multi-conductor cable, 6-ft, 9-pin female to 9-pin male. (1)
 Model 488B14/NC POWER CONVERTOR (1)
 Model EE75 PCB MCSC Control Software. (1)

Entered: AP	Engineer: AJP	Sales: JJM	Approved: JWH	Spec Number:
Date: 1/31/2013	Date: 1/31/2013	Date: 1/31/2013	Date: 1/31/2013	43264



All specifications are at room temperature unless otherwise specified.
 In the interest of constant product improvement, we reserve the right to change specifications without notice.
 ICP® is a registered trademark of PCB Group, Inc.



Model 488B14/NC

Accessory for Electronics Division Product

Installation and Operating Manual

**For assistance with the operation of this product,
contact PCB Piezotronics, Inc.**

**Toll-free: 800-828-8840
24-hour SensorLine: 716-684-0001
Fax: 716-684-0987
E-mail: info@pcb.com
Web: www.pcb.com**



Repair and Maintenance

PCB guarantees Total Customer Satisfaction through its “Lifetime Warranty Plus” on all Platinum Stock Products sold by PCB and through its limited warranties on all other PCB Stock, Standard and Special products. Due to the sophisticated nature of our sensors and associated instrumentation, **field servicing and repair is not recommended and, if attempted, will void the factory warranty.**

Beyond routine calibration and battery replacements where applicable, our products require no user maintenance. Clean electrical connectors, housings, and mounting surfaces with solutions and techniques that will not harm the material of construction. Observe caution when using liquids near devices that are not hermetically sealed. Such devices should only be wiped with a dampened cloth—never saturated or submerged.

In the event that equipment becomes damaged or ceases to operate, our Application Engineers are here to support your troubleshooting efforts 24 hours a day, 7 days a week. Call or email with model and serial number as well as a brief description of the problem.

Calibration

Routine calibration of sensors and associated instrumentation is necessary to maintain measurement accuracy. We recommend calibrating on an annual basis, after exposure to any extreme environmental influence, or prior to any critical test.

PCB Piezotronics is an ISO-9001 certified company whose calibration services are accredited by A2LA to ISO/IEC 17025, with full traceability to SI through N.I.S.T. In addition to our standard calibration services, we also offer specialized tests, including: sensitivity at elevated or cryogenic temperatures, phase response, extended high or low frequency response, extended range, leak testing, hydrostatic pressure testing, and others. For more information, contact your local PCB Piezotronics distributor, sales representative, or factory customer service representative.

Returning Equipment

If factory repair is required, our representatives will provide you with a Return Material Authorization (RMA) number, which we use to reference any information you have already provided and expedite the repair process. This number should be clearly marked on the outside of all returned package(s) and on any packing list(s) accompanying the shipment.

Contact Information

PCB Piezotronics, Inc.
3425 Walden Ave.
Depew, NY14043 USA
Toll-free: (800) 828-8840
24-hour SensorLine: (716) 684-0001
General inquiries: info@pcb.com
Repair inquiries: rma@pcb.com

For a complete list of distributors, global offices and sales representatives, visit our website, www.pcb.com.

Safety Considerations

This product is intended for use by qualified personnel who recognize shock hazards and are familiar with the precautions required to avoid injury. While our equipment is designed with user safety in mind, the protection provided by the equipment may be impaired if equipment is used in a manner not specified by this manual.

Discontinue use and contact our 24-Hour Sensorline if:

- Assistance is needed to safely operate equipment
- Damage is visible or suspected
- Equipment fails or malfunctions

For complete equipment ratings, refer to the enclosed specification sheet for your product.

Definition of Terms and Symbols

The following symbols may be used in this manual:



DANGER

Indicates an immediate hazardous situation, which, if not avoided, may result in death or serious injury.

**CAUTION**

Refers to hazards that could damage the instrument.

**NOTE**

Indicates tips, recommendations and important information. The notes simplify processes and contain additional information on particular operating steps.

The following symbols may be found on the equipment described in this manual:



This symbol on the unit indicates that high voltage may be present. Use standard safety precautions to avoid personal contact with this voltage.



This symbol on the unit indicates that the user should refer to the operating instructions located in the manual.



This symbol indicates safety, earth ground.



PCB工业监视和测量设备 - 中国RoHS2公布表

PCB Industrial Monitoring and Measuring Equipment - China RoHS 2 Disclosure Table

部件名称	有害物质					
	铅 (Pb)	汞 (Hg)	镉 (Cd)	六价铬 (Cr(VI))	多溴联苯 (PBB)	多溴二苯醚 (PBDE)
住房	0	0	0	0	0	0
PCB板	X	0	0	0	0	0
电气连接器	0	0	0	0	0	0
压电晶体	X	0	0	0	0	0
环氧	0	0	0	0	0	0
铁氟龙	0	0	0	0	0	0
电子	0	0	0	0	0	0
厚膜基板	0	0	X	0	0	0
电线	0	0	0	0	0	0
电缆	X	0	0	0	0	0
塑料	0	0	0	0	0	0
焊接	X	0	0	0	0	0
铜合金/黄铜	X	0	0	0	0	0
本表格依据 SJ/T 11364 的规定编制。						
0：表示该有害物质在该部件所有均质材料中的含量均在 GB/T 26572 规定的限量要求以下。						
X：表示该有害物质至少在该部件的某一均质材料中的含量超出 GB/T 26572 规定的限量要求。						
铅是欧洲RoHS指令2011/65/ EU附件三和附件四目前由于允许的豁免。						

CHINA RoHS COMPLIANCE

Component Name	Hazardous Substances					
	Lead (Pb)	Mercury (Hg)	Cadmium (Cd)	Chromium VI Compounds (Cr(VI))	Polybrominated Biphenyls (PBB)	Polybrominated Diphenyl Ethers (PBDE)
Housing	O	O	O	O	O	O
PCB Board	X	O	O	O	O	O
Electrical Connectors	O	O	O	O	O	O
Piezoelectric Crystals	X	O	O	O	O	O
Epoxy	O	O	O	O	O	O
Teflon	O	O	O	O	O	O
Electronics	O	O	O	O	O	O
Thick Film Substrate	O	O	X	O	O	O
Wires	O	O	O	O	O	O
Cables	X	O	O	O	O	O
Plastic	O	O	O	O	O	O
Solder	X	O	O	O	O	O
Copper Alloy/Brass	X	O	O	O	O	O

This table is prepared in accordance with the provisions of SJ/T 11364.

O: Indicates that said hazardous substance contained in all of the homogeneous materials for this part is below the limit requirement of GB/T 26572.

X: Indicates that said hazardous substance contained in at least one of the homogeneous materials for this part is above the limit requirement of GB/T 26572.

Lead is present due to allowed exemption in Annex III or Annex IV of the European RoHS Directive 2011/65/EU.

Model Number

488B14

POWER SUPPLY

Revision: NR
ECN #:**Environmental**Temperature Range(Operating)
Humidity Range(Non-Condensing)**ENGLISH**32 to 104 °F
0 to 95 %**SI**0 to 40 °C
0 to 95 %**Electrical**Output Voltage
Output Current
AC Power(50 to 60 Hz)
(50 to 60 Hz)11.5 - 12.5 VDC
2.5 amps
100 to 240 VAC
1.0 amps
<120 mV11.5 - 12.5 VDC
2.5 amps
100 to 240 VAC
1.0 amps
<120 mV

AC Ripple(Peak to Peak)

PhysicalElectrical Connector(AC Power Input)
(Output DC)IEC 320
6-pin mini DIN (male)IEC 320
6-pin mini DIN (male)

Size (Height x Width x Depth)

1.3 in x 2.13 in x 3.76 in

33 mm x 54.1 mm x 95.5 mm

Weight

1.25 lb

0.57 kg

OPTIONAL VERSIONS

Optional versions have identical specifications and accessories as listed for the standard model except where noted below. More than one option may be used.

488B14/NC - Does not include a 017AXX Power Cord**NOTES:**

[1] See PCB Declaration of Conformance PS024 for details.

SUPPLIED ACCESSORIES:

Model 017AXX Power Cord (1)

Entered: <i>Lu</i>	Engineer: <i>PH</i>	Sales: <i>Qm</i>	Approved: <i>EB</i>	Spec Number:
Date: <i>3-26-10</i>	Date: <i>3-19-10</i>	Date: <i>3-19-10</i>	Date: <i>3-23-10</i>	45179



[1]

All specifications are at room temperature unless otherwise specified.

In the interest of constant product improvement, we reserve the right to change specifications without notice.

ICP® is a registered trademark of PCB Group, Inc.

PCB PIEZOTRONICS
ELECTRONICS DIVISION
3425 Walden Avenue, Depew, NY 14043

Phone: 716-684-0001

Fax: 716-684-0987

E-Mail: electronics@pcb.com



Model 482C27

Bridge/Differential, ICP®/Voltage Sensor Signal Conditioner

Installation and Operating Manual

**For assistance with the operation of this product,
contact PCB Piezotronics, Inc.**

**Toll-free: 800-828-8840
24-hour SensorLine: 716-684-0001
Fax: 716-684-0987
E-mail: info@pcb.com
Web: www.pcb.com**



Repair and Maintenance

PCB guarantees Total Customer Satisfaction through its “Lifetime Warranty Plus” on all Platinum Stock Products sold by PCB and through its limited warranties on all other PCB Stock, Standard and Special products. Due to the sophisticated nature of our sensors and associated instrumentation, **field servicing and repair is not recommended and, if attempted, will void the factory warranty.**

Beyond routine calibration and battery replacements where applicable, our products require no user maintenance. Clean electrical connectors, housings, and mounting surfaces with solutions and techniques that will not harm the material of construction. Observe caution when using liquids near devices that are not hermetically sealed. Such devices should only be wiped with a dampened cloth—never saturated or submerged.

In the event that equipment becomes damaged or ceases to operate, our Application Engineers are here to support your troubleshooting efforts 24 hours a day, 7 days a week. Call or email with model and serial number as well as a brief description of the problem.

Calibration

Routine calibration of sensors and associated instrumentation is necessary to maintain measurement accuracy. We recommend calibrating on an annual basis, after exposure to any extreme environmental influence, or prior to any critical test.

PCB Piezotronics is an ISO-9001 certified company whose calibration services are accredited by A2LA to ISO/IEC 17025, with full traceability to SI through N.I.S.T. In addition to our standard calibration services, we also offer specialized tests, including: sensitivity at elevated or cryogenic temperatures, phase response, extended high or low frequency response, extended range, leak testing, hydrostatic pressure testing, and others. For more information, contact your local PCB Piezotronics distributor, sales representative, or factory customer service representative.

Returning Equipment

If factory repair is required, our representatives will provide you with a Return Material Authorization (RMA) number, which we use to reference any information you have already provided and expedite the repair process. This number should be clearly marked on the outside of all returned package(s) and on any packing list(s) accompanying the shipment.

Contact Information

PCB Piezotronics, Inc.
3425 Walden Ave.
Depew, NY14043 USA
Toll-free: (800) 828-8840
24-hour SensorLine: (716) 684-0001
General inquiries: info@pcb.com
Repair inquiries: rma@pcb.com

For a complete list of distributors, global offices and sales representatives, visit our website, www.pcb.com.

Safety Considerations

This product is intended for use by qualified personnel who recognize shock hazards and are familiar with the precautions required to avoid injury. While our equipment is designed with user safety in mind, the protection provided by the equipment may be impaired if equipment is used in a manner not specified by this manual.

Discontinue use and contact our 24-Hour Sensorline if:

- Assistance is needed to safely operate equipment
- Damage is visible or suspected
- Equipment fails or malfunctions

For complete equipment ratings, refer to the enclosed specification sheet for your product.

Definition of Terms and Symbols

The following symbols may be used in this manual:



DANGER

Indicates an immediate hazardous situation, which, if not avoided, may result in death or serious injury.

**CAUTION**

Refers to hazards that could damage the instrument.

**NOTE**

Indicates tips, recommendations and important information. The notes simplify processes and contain additional information on particular operating steps.

The following symbols may be found on the equipment described in this manual:



This symbol on the unit indicates that high voltage may be present. Use standard safety precautions to avoid personal contact with this voltage.



This symbol on the unit indicates that the user should refer to the operating instructions located in the manual.



This symbol indicates safety, earth ground.



PCB工业监视和测量设备 - 中国RoHS2公布表

PCB Industrial Monitoring and Measuring Equipment - China RoHS 2 Disclosure Table

部件名称	有害物质					
	铅 (Pb)	汞 (Hg)	镉 (Cd)	六价铬 (Cr(VI))	多溴联苯 (PBB)	多溴二苯醚 (PBDE)
住房	0	0	0	0	0	0
PCB板	X	0	0	0	0	0
电气连接器	0	0	0	0	0	0
压电晶体	X	0	0	0	0	0
环氧	0	0	0	0	0	0
铁氟龙	0	0	0	0	0	0
电子	0	0	0	0	0	0
厚膜基板	0	0	X	0	0	0
电线	0	0	0	0	0	0
电缆	X	0	0	0	0	0
塑料	0	0	0	0	0	0
焊接	X	0	0	0	0	0
铜合金/黄铜	X	0	0	0	0	0
本表格依据 SJ/T 11364 的规定编制。						
0：表示该有害物质在该部件所有均质材料中的含量均在 GB/T 26572 规定的限量要求以下。						
X：表示该有害物质至少在该部件的某一均质材料中的含量超出 GB/T 26572 规定的限量要求。						
铅是欧洲RoHS指令2011/65/ EU附件三和附件四目前由于允许的豁免。						

CHINA RoHS COMPLIANCE

Component Name	Hazardous Substances					
	Lead (Pb)	Mercury (Hg)	Cadmium (Cd)	Chromium VI Compounds (Cr(VI))	Polybrominated Biphenyls (PBB)	Polybrominated Diphenyl Ethers (PBDE)
Housing	O	O	O	O	O	O
PCB Board	X	O	O	O	O	O
Electrical Connectors	O	O	O	O	O	O
Piezoelectric Crystals	X	O	O	O	O	O
Epoxy	O	O	O	O	O	O
Teflon	O	O	O	O	O	O
Electronics	O	O	O	O	O	O
Thick Film Substrate	O	O	X	O	O	O
Wires	O	O	O	O	O	O
Cables	X	O	O	O	O	O
Plastic	O	O	O	O	O	O
Solder	X	O	O	O	O	O
Copper Alloy/Brass	X	O	O	O	O	O

This table is prepared in accordance with the provisions of SJ/T 11364.

O: Indicates that said hazardous substance contained in all of the homogeneous materials for this part is below the limit requirement of GB/T 26572.

X: Indicates that said hazardous substance contained in at least one of the homogeneous materials for this part is above the limit requirement of GB/T 26572.

Lead is present due to allowed exemption in Annex III or Annex IV of the European RoHS Directive 2011/65/EU.

PCB Piezotronics Inc. claims proprietary rights in the information disclosed hereon. Neither it nor any reproduction thereof will be disclosed to others without the written consent of PCB Piezotronics Inc.

REVISIONS		
REV	DESCRIPTION	ECO
NR	RELEASED TO DRAFTING	
A	ADD TRADEMARK TO "ICP"	31293

43176

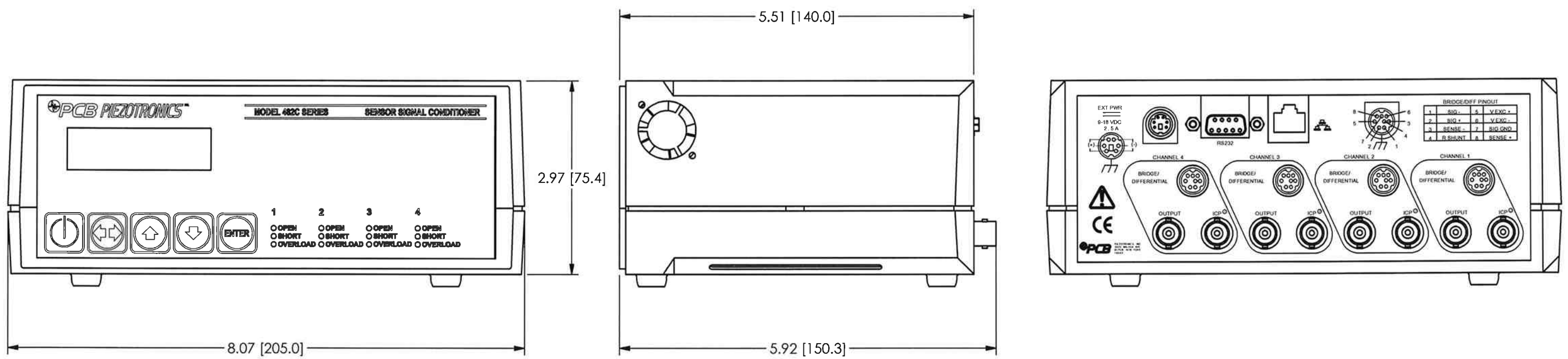

UNLESS OTHERWISE SPECIFIED TOLERANCES ARE:		DRAWN	CHECKED	ENGINEER	
DIMENSIONS IN INCHES	DIMENSIONS IN MILLIMETERS [IN BRACKETS]	MDP 9/2/09	ECB 9/2/09	PH	9/2/09
DECIMALS XX ±.03 XXX ±.010	DECIMALS X ± 0.8 XX ± 0.25	TITLE OUTLINE DRAWING MODEL 482C27 SIGNAL CONDITIONER			
ANGLES ± 2 DEGREES	ANGLES ± 2 DEGREES				
FILLETS AND RADII .003 - .005	FILLETS AND RADII 0.07 - 0.13	CODE IDENT. NO. 52681		DWG. NO. 43176	
		SCALE: .625X		SHEET 1 OF 1	

PCB PIEZOTRONICS
 3425 WALDEN AVE. DEPEW, NY 14043
 (716) 684-0001 E-MAIL: sales@pcb.com