



**Model 649A03**  
**Bearing Fault Detector PLUS**  
**Installation and Operating Manual**

**For assistance with the operation of this product,  
contact PCB Piezotronics, Inc.**

**Toll-free: 800-959-4464**  
**24-hour SensorLine: 716-684-0001**  
**Fax: 716-684-3823**  
**E-mail: [imi@pcb.com](mailto:imi@pcb.com)**  
**Web: [www.imi-sensors.com](http://www.imi-sensors.com)**



## Repair and Maintenance

PCB guarantees Total Customer Satisfaction through its “Lifetime Warranty Plus” on all Platinum Stock Products sold by PCB and through its limited warranties on all other PCB Stock, Standard and Special products. Due to the sophisticated nature of our sensors and associated instrumentation, **field servicing and repair is not recommended and, if attempted, will void the factory warranty.**

Beyond routine calibration and battery replacements where applicable, our products require no user maintenance. Clean electrical connectors, housings, and mounting surfaces with solutions and techniques that will not harm the material of construction. Observe caution when using liquids near devices that are not hermetically sealed. Such devices should only be wiped with a dampened cloth—never saturated or submerged.

In the event that equipment becomes damaged or ceases to operate, our Application Engineers are here to support your troubleshooting efforts 24 hours a day, 7 days a week. Call or email with model and serial number as well as a brief description of the problem.

## Calibration

Routine calibration of sensors and associated instrumentation is necessary to maintain measurement accuracy. We recommend calibrating on an annual basis, after exposure to any extreme environmental influence, or prior to any critical test.

PCB Piezotronics is an ISO-9001 certified company whose calibration services are accredited by A2LA to ISO/IEC 17025, with full traceability to SI through N.I.S.T. In addition to our standard calibration services, we also offer specialized tests, including: sensitivity at elevated or cryogenic temperatures, phase response, extended high or low frequency response, extended range, leak testing, hydrostatic pressure testing, and others. For more information, contact your local PCB Piezotronics distributor, sales representative, or factory customer service representative.

## Returning Equipment

If factory repair is required, our representatives will provide you with a Return Material Authorization (RMA) number, which we use to reference any information you have already provided and expedite the repair process. This number should be clearly marked on the outside of all returned package(s) and on any packing list(s) accompanying the shipment.

## Contact Information

PCB Piezotronics, Inc.  
3425 Walden Ave.  
Depew, NY14043 USA  
Toll-free: (800) 828-8840  
24-hour SensorLine: (716) 684-0001  
General inquiries: [info@pcb.com](mailto:info@pcb.com)  
Repair inquiries: [rma@pcb.com](mailto:rma@pcb.com)

For a complete list of distributors, global offices and sales representatives, visit our website, [www.pcb.com](http://www.pcb.com).

## Safety Considerations

This product is intended for use by qualified personnel who recognize shock hazards and are familiar with the precautions required to avoid injury. While our equipment is designed with user safety in mind, the protection provided by the equipment may be impaired if equipment is used in a manner not specified by this manual.

Discontinue use and contact our 24-Hour Sensorline if:

- Assistance is needed to safely operate equipment
- Damage is visible or suspected
- Equipment fails or malfunctions

For complete equipment ratings, refer to the enclosed specification sheet for your product.

## Definition of Terms and Symbols

The following symbols may be used in this manual:



### DANGER

Indicates an immediate hazardous situation, which, if not avoided, may result in death or serious injury.

**CAUTION**

Refers to hazards that could damage the instrument.

**NOTE**

Indicates tips, recommendations and important information. The notes simplify processes and contain additional information on particular operating steps.

**The following symbols may be found on the equipment described in this manual:**



This symbol on the unit indicates that high voltage may be present. Use standard safety precautions to avoid personal contact with this voltage.



This symbol on the unit indicates that the user should refer to the operating instructions located in the manual.



This symbol indicates safety, earth ground.



PCB工业监视和测量设备 - 中国RoHS2公布表

PCB Industrial Monitoring and Measuring Equipment - China RoHS 2 Disclosure Table

部件名称	有害物质					
	铅 (Pb)	汞 (Hg)	镉 (Cd)	六价铬 (Cr(VI))	多溴联苯 (PBB)	多溴二苯醚 (PBDE)
住房	0	0	0	0	0	0
PCB板	X	0	0	0	0	0
电气连接器	0	0	0	0	0	0
压电晶体	X	0	0	0	0	0
环氧	0	0	0	0	0	0
铁氟龙	0	0	0	0	0	0
电子	0	0	0	0	0	0
厚膜基板	0	0	X	0	0	0
电线	0	0	0	0	0	0
电缆	X	0	0	0	0	0
塑料	0	0	0	0	0	0
焊接	X	0	0	0	0	0
铜合金/黄铜	X	0	0	0	0	0
本表格依据 SJ/T 11364 的规定编制。						
0：表示该有害物质在该部件所有均质材料中的含量均在 GB/T 26572 规定的限量要求以下。						
X：表示该有害物质至少在该部件的某一均质材料中的含量超出 GB/T 26572 规定的限量要求。						
铅是欧洲RoHS指令2011/65/ EU附件三和附件四目前由于允许的豁免。						

CHINA RoHS COMPLIANCE

Component Name	Hazardous Substances					
	Lead (Pb)	Mercury (Hg)	Cadmium (Cd)	Chromium VI Compounds (Cr(VI))	Polybrominated Biphenyls (PBB)	Polybrominated Diphenyl Ethers (PBDE)
Housing	O	O	O	O	O	O
PCB Board	X	O	O	O	O	O
Electrical Connectors	O	O	O	O	O	O
Piezoelectric Crystals	X	O	O	O	O	O
Epoxy	O	O	O	O	O	O
Teflon	O	O	O	O	O	O
Electronics	O	O	O	O	O	O
Thick Film Substrate	O	O	X	O	O	O
Wires	O	O	O	O	O	O
Cables	X	O	O	O	O	O
Plastic	O	O	O	O	O	O
Solder	X	O	O	O	O	O
Copper Alloy/Brass	X	O	O	O	O	O

This table is prepared in accordance with the provisions of SJ/T 11364.

O: Indicates that said hazardous substance contained in all of the homogeneous materials for this part is below the limit requirement of GB/T 26572.

X: Indicates that said hazardous substance contained in at least one of the homogeneous materials for this part is above the limit requirement of GB/T 26572.

Lead is present due to allowed exemption in Annex III or Annex IV of the European RoHS Directive 2011/65/EU.



---

*Operating Guide with Enclosed Warranty Information*

*3425 Walden Avenue, Depew, New York 14043-2495*

*Phone (716) 684-0003*

*Fax (716) 684-3823*

*Toll Free Line 1-800-959-4IMI*

*MANUAL NUMBER: 45611*

*MANUAL REVISION: **F***

*ECN NUMBER: **49766***

**Table of Contents**

---

<i>Introduction</i> .....	<i>Page 3</i>
<i>General Features</i>	
<i>Operating Principles</i> .....	<i>Page 4</i>
<i>Outputs</i>	
<i>Installation</i> .....	<i>Page 7</i>
<i>Direct Adhesive Mount</i>	
<i>Standard Stud Mount</i>	
<i>Adhesive Stud Mount</i>	
<i>Magnetic Mount</i>	
<i>Wiring</i> .....	<i>Page 11</i>
<i>Programming Software</i> .....	<i>Page 12</i>
<i>Program Installation</i>	
<i>Running the Software</i>	
<i>Programming Sections</i>	
<i>Reading and Writing Parameters</i>	
<i>Parameter Options</i>	
<i>Portable 4-20 mA Loop Calibrator</i> .....	<i>Page 18</i>
<i>Cable Ordering Information</i> .....	<i>Page 19</i>
<i>ESD Sensitivity</i> .....	<i>Page 20</i>
<i>Warranty, Service &amp; Return Procedure</i> .....	<i>Page 21</i>
<i>Customer Service</i> .....	<i>Page 21</i>

## ***Introduction***

---

The (CS)649AX3-Series Bearing Fault Detector PLUS is a USB-programmable, loop-powered device with 4-20mA output, all contained in typical vibration sensor housing. It is specifically designed to provide early warning of typical ball/rolling element bearing faults such as cracked races, spalling, brinelling and looseness. It has five modes of detection that are user-selectable by a simple software program through a PC's USB port- RMS Acceleration, True Peak Acceleration, Compensated Peak Acceleration, Crest Factor and Crest Factor Plus.

Every BFD+ is factory-programmed. See Page 16 for more information.

## ***General Features***

- Embedded piezoelectric accelerometer for improved accuracy and frequency response.
- Field-programmable vibration range for true peak acceleration, RMS acceleration, compensated peak acceleration (peak acceleration with correction), crest factor or crest factor plus.
- Easily interfaces with existing process control and predictive maintenance equipment.
- Rugged stainless steel, hermetically-sealed construction for applications in harsh environments.



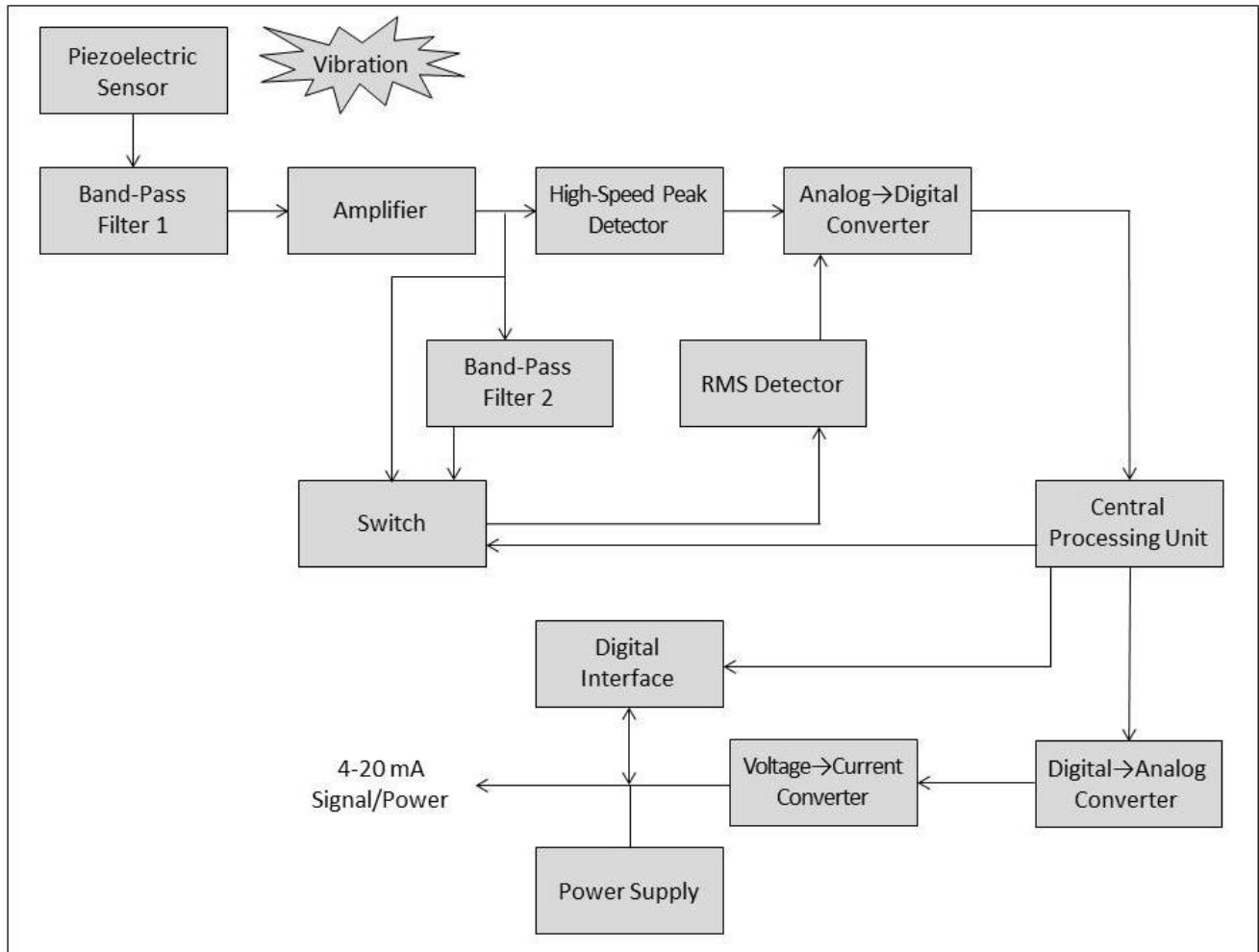

**Figure 1 – Block Diagram**

A block diagram is shown above. BFD+ includes an embedded piezoelectric sensor that generates a voltage output that is proportional to the sensed vibration. The output of the sensor is passed through a band-pass filter (250 Hz to 10+ kHz) and then an amplifier. The signal is then passed through a high-speed peak detector and through another band-pass filter (2.5 kHz to 10+kHz) or directly to a true RMS detector.

The high-speed peak detector and RMS detector monitor the continuous vibration signal and hold the highest values seen within the sample window. The peak and RMS values are passed through the analog-to-digital convertor to the central processing unit. The sensor output is a 4-20 mA current proportional to measured parameter based on the USB programmed settings.

## Outputs

### True Peak Acceleration

- **Details:** This is the highest acceleration value captured within the sampling window. The acceleration signal used for this output is high pass filtered at 250 Hz.
- **Best Uses:** This is the best and most commonly used method for early detection of bearing wear for fixed speed machinery. The peak capture and high pass filtering provide values that strongly correlate to the severity of cracks, spalling or brinelling. The short pulse cause by these faults has low energy compared to the overall broadband vibration, and therefore would typically get lost in a traditional RMS measurement.

### RMS Acceleration

- **Details:** This is the arithmetic average of all values captured within the sampling window. The acceleration signal used for this output is high pass filtered at 2500 Hz.
- **Best Uses:** RMS Acceleration can be used when it is preferred to run a bearing close to failure before raising an alarm. It is also helpful for processes which involve violent impacting and short, high-amplitude pulses that can transfer through the machinery to the bearing. In these cases, using the RMS Acceleration output avoids false trips caused by these high-energy, short duration vibrations. The True Peak Acceleration output may increase greatly with one of these impacts, but the RMS Acceleration will not significantly increase.

### Compensated Peak Acceleration (Peak Acceleration with Correction)

- **Details:** This is a normalized ratio of the acceleration of impacts within the bearing to the linear speed of the rolling element passing over a defect. This uses the speed and diameter of the bearing that were programmed into the sensor to determine the linear velocity of the rolling element. The output is a unit-less severity scale from 1 to 16. The acceleration signals used for this output are high pass filtered at 250 Hz.
- **Best Uses:** Compensated Peak Acceleration is most helpful for when the user has various size and speed machinery for which they would like to monitor the rolling element bearings. By normalizing the output using the shock pulse method described above, the values will be similar for machines with the same bearing condition, even if these machines vary greatly in size and speed. Therefore a single alarm limit can be set in the control system for all monitored bearings across different pieces of machinery.

### Crest Factor

- **Details:** This is the ratio of True Peak to RMS Acceleration. Therefore this value increases as the amplitude of high-frequency impacts in the bearing increase compared to the amplitude of broadband overall vibration. The output is a unit-less severity scale from 1 to 16. The acceleration signals used for this output are high pass filtered at 250 Hz.
- **Best Uses:** Crest Factor is better suited for variable speed machinery because the ratio of Peak to RMS acceleration should not vary much at different speeds. This is due to the fact that both will increase as speed increases; however, only True Peak Acceleration will increase if the fault severity increases in the early stages of bearing failure. Please note that once the bearing condition is poor enough, the fault vibrations will actually start to cause the RMS Acceleration value to increase, and therefore the Crest Factor starts to decrease as the condition gets worse. Trending this Crest Factor value can capture that decrease and still provide accurate awareness of the bearing condition. If you are not able to trend these values or would like a similar output that always increases as bearing condition worsens, consider using the Crest Factor + output described below.

### Crest Factor Plus

- Details:** This is similar to Crest Factor, but the output has been adjusted such that the value always increases as the bearing condition gets worse. This uses a sum of Crest Factor, RMS Acceleration, and True Peak Acceleration. These are weighted differently such that the sum of the three always increases as bearing condition gets worse, even if 1 value decreases. This primarily corrects for the fact that Crest Factor decreases when the fault is very severe. By adding RMS Acceleration into the equation, the decreasing Crest Factor is counteracted by the increasing RMS Acceleration as bearing condition is very poor. The output is a unit-less severity scale from 1 to 16. The acceleration signals used for this output are high pass filtered at 250 Hz.
- Best Uses:** Crest Factor Plus is best suited for variable speed machinery when trending is not possible or not desired. The value will always increase over the entire life cycle of the bearing as its condition worsens. This allows the user to simply set an alarm value for the severity scale and not worry about keeping historical data for trend monitoring.

Scaled Output (1-16)	Bearing Condition
1 to 5	Good
6 to 11	Satisfactory
12 to 15	Unsatisfactory
Above 15	Unacceptable

**Figure 2 – Bearing Condition Guide for Compensated Peak Acceleration, Crest Factor and Crest Factor Plus**

## Installation

---

When choosing a mounting method, consider closely the advantages and disadvantages of each technique. Typical mounting types are stud, direct adhesive, adhesive mounting base and magnetic mounting base. Stud mounting is highly recommended for the BFD+ since it has a frequency response upwards of 10 kHz and most of the output signals are directly related to high frequency energy. Model CS649A93 has a ¼" NPT mounting thread.

### Direct Adhesive Mount Procedure

For restrictions of space or for convenience, most sensors (with the exception of integral stud models) can be adhesive-mounted directly to the machine surface.

- Step 1: Prepare a smooth, flat mounting surface. A minimum surface finish of 63  $\mu\text{in}$  (0.0016 mm) generally works best.
- Step 2: Place a small portion of adhesive on the underside of the sensor. Firmly press down on the top of the assembly to displace any adhesive. Be aware that excessive amounts of adhesive can make sensor removal difficult.

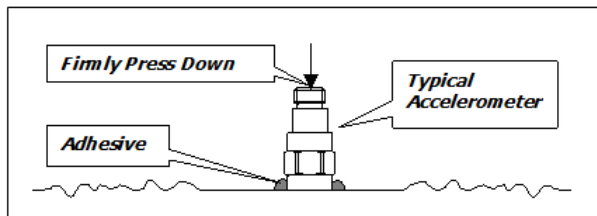

Figure 3 – Direct Adhesive Mounting

### Standard Stud Mount Procedure

This mounting technique requires smooth, flat contact surfaces for proper operation and is recommended for permanent and/or secure installations. Stud mounting is also recommended when testing at high frequencies.

Note: Do not attempt mounting on curved, rough or uneven surfaces, as the potential for misalignment and limited contact surface may significantly reduce the sensor's upper operating frequency range.

	¼-28 Stud	¼-28 Captive Screw
A (in)	0.250	0.250
B (in)	0.350	0.350
Torque (ft-lb)	2 to 5	2 to 5

- Step 1: First, prepare a smooth, flat mounting surface and then drill and tap a mounting hole in the center of this area. A precision-machined mounting surface with a minimum finish of 63 µin (0.0016 mm) is recommended. (If it is not possible to properly prepare the machine surface, consider using an adhesive mounting pad as a possible alternative.) Inspect the area, checking that there are no burrs or other foreign particles interfering with the contact surface.
- Step 2: Wipe clean the mounting surface and spread on a light film of grease, oil or similar coupling fluid prior to installation. Adding a coupling fluid improves vibration transmissibility by filling small voids in the mounting surface and increasing the mounting stiffness. For semi-permanent mounting, substitute epoxy or another type of adhesive.
- Step 3: Hand-tighten the sensor/mounting stud to the machine, and then secure the sensor with a torque wrench to the mounting surface by applying the recommended mounting torque (see enclosed specification data sheet for proper mounting torque). It is important to use a torque wrench during this step. Under-torquing the sensor may not adequately couple the device; over-torquing may result in stud failure and possibly permanent damage.

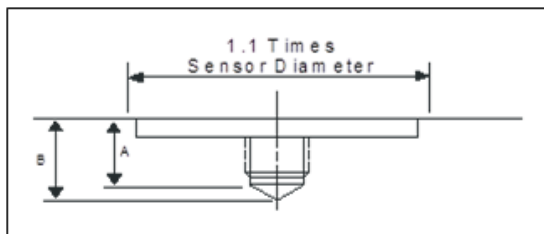

Figure 4 – Mounting Surface Preparation

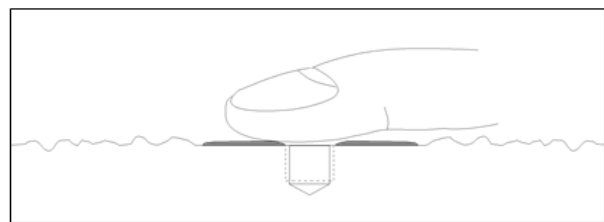

Figure 5 – Mounting Surface Lubrication

### **Adhesive Stud Mount Procedure**

Adhesive mounting is often used for temporary installation or when the machine surface cannot be adequately prepared for stud mounting. Adhesives like hot glue or wax work well for temporary mounts; two-part epoxies and quick-bonding gels provide a more permanent mount.

---

Note: Adhesively mounted sensors often exhibit a reduction in high-frequency range. Generally, smooth surfaces and stiff adhesives provide the best frequency response. Contact the factory for recommended epoxies.

---

This method involves attaching a base to the machine surface, then securing the sensor to the base. This allows for easy removal of the accelerometer.

- Step 1: Prepare a smooth, flat mounting surface. A minimum surface finish of 63  $\mu\text{in}$  (0.0016 mm) generally works best.
- Step 2: Stud-mount the sensor to the appropriate adhesive mounting base according to the guidelines set forth in Steps 2 and 3 of the Standard Stud Mount Procedure.
- Step 3: Place a small portion of adhesive on the underside of the mounting base. Firmly press down on the assembly to displace any extra adhesive remaining under the base.

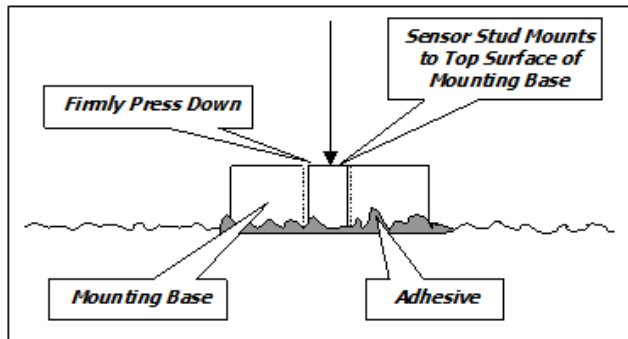

**Figure 6 – Adhesive Installation of Mounting Base**

### **Magnetic Mount Procedure**

Magnetic mounting provides a convenient means for making portable measurements and is commonly used for machinery monitoring and other portable or trending applications.

---

Note: The correct magnet choice and an adequately prepared mounting surface are critical for obtaining reliable measurements, especially at high frequencies. Poor installations can cause as much as a 50% drop in the sensor frequency range.

---

Not every magnet is suitable for all applications. For example, rare earth magnets are commonly used because of their high strength. Flat magnets work well on smooth, flat surfaces, while dual-rail magnets are required for curved surfaces. In the case of non-magnetic or rough surfaces, it is recommended that the user first weld, epoxy or otherwise adhere a steel mounting pad to the test surface. This provides a smooth and repeatable location for mounting.

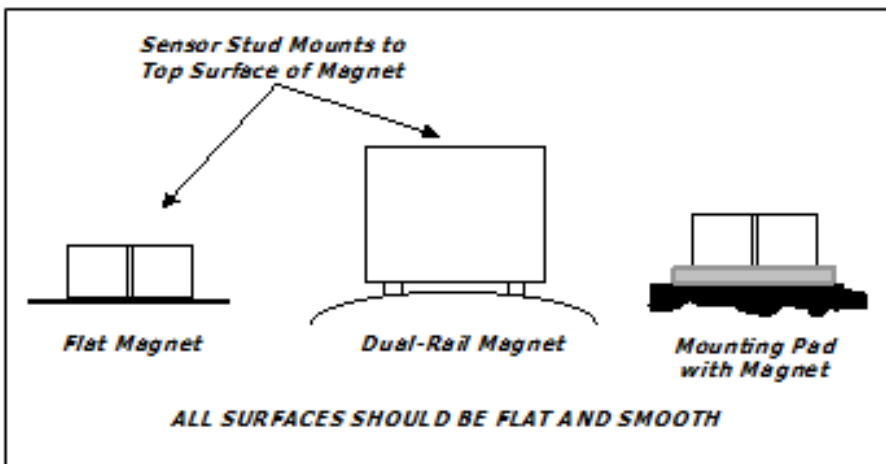

**Figure 7 – Magnet Types**

- Step 1: After choosing the correct magnet, inspect the unit to verify that the mounting surfaces are flat and smooth.
- Step 2: Stud-mount the accelerometer to the appropriate magnet according to the guidelines set forth in Steps 2 and 3 of the Standard Stud Mount Procedure.
- Step 3: Prepare a smooth, flat mounting surface. A minimum surface finish of 63  $\mu\text{in}$  [0.0016 mm] generally works best. After cleaning the surface and checking for burrs, wipe on a light film of silicone grease, machine oil or similar-type coupling fluid.
- Step 4: Mount the magnet/sensor assembly to the prepared test surface by gently “rocking” or “sliding” it into place.

---

Note: Magnetically mounting accelerometers carelessly has the potential to generate very high (and very damaging) g levels. To prevent damage, install the assembly gently. If unsure, please contact the factory for assistance.

---

## Wiring

BFD+ operates from a standard 2-wire, 4-20mA loop. If using a loop powered unit, attach the positive (+) input from the power supply to Pin A on the sensor and the negative (-) input from the power supply to Pin of the sensor.

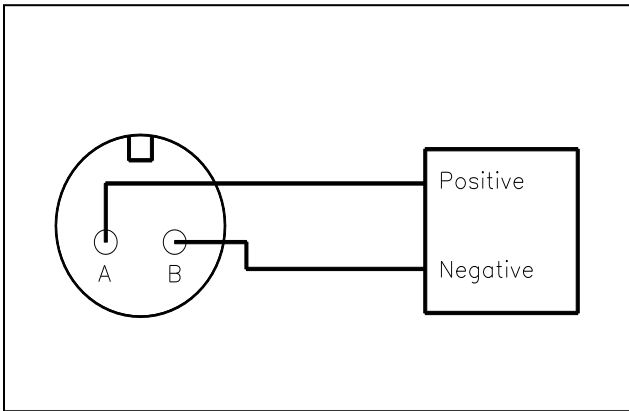

Figure 8 – Loop-Powered Wiring

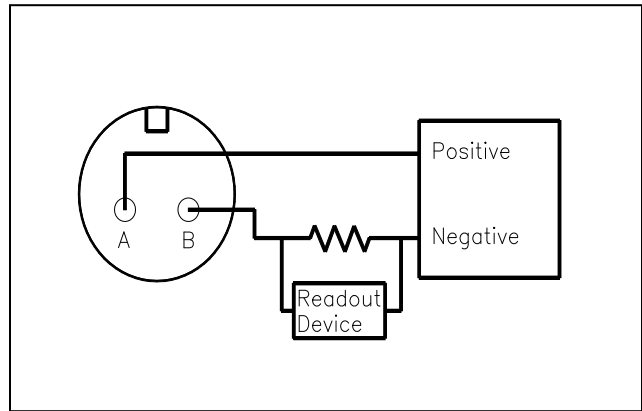

Figure 9 – Loop-Powered Wiring with DC Source

If using a standard DC power supply, install either an ammeter and/or load resistor in line with the output.

The resistor will generate a DC voltage that is proportional to current by:

$$V = IR$$

*If  $R = 500 \text{ ohms}$  and  $I = 6 \text{ mA}$ , then  $V = 3 \text{ VDC}$*

### Note:

- Resistor value must be less than:  $(V_{\text{supply}} - 12) \times 50$ .
- For integral cable sensors: RED wire is positive, BLUE wire is negative.
- For flying lead sensors: RED wire is positive, BLACK wire is negative.



**Programming Software**

The BFD+ can be user-programmed with either of two optional programming kits, Model 600A21 (non-ROHS compliant) or Model 600A35 (ROHS compliant). Both kits include a USB programmer cable/dongle (Model 600A21 kit includes Model 070A89 cable; Model 600A35 kit includes Model 070A103 cable), software (Model EE225) and terminal block/integral cable adapter (Model 042M17). The software can also be downloaded from IMI's website, [www.pcb.com](http://www.pcb.com). This software must be installed prior to connecting the BFD+ to the computer using the USB programmer cable. The software includes both the drivers and user interface needed for programming the BFD+. During initial installation, you may need administrative rights for the computer in order to install the drivers. Once installed, administrative rights are not required for use.



**Figure 10 – Model 600A21/600A35 USB Programmer Kit**

**Program Installation**

Installing the Software and USB Driver: Insert the software CD provided into the CD drive. The software will start the installation automatically if your PC is set to auto-install applications. If not, browse the CD and click on Setup.exe to start the installation process. The default installation directory is C:\PCB\EE225. It is recommended to use the default setting.

The installer will first install the software and then the WinUSB device driver. This device driver is required for the programmer software to communicate with the 070A89 or 070A103 USB programmer cable.

The following screens will be displayed when the installer starts. Click the Next button to proceed from step to step.

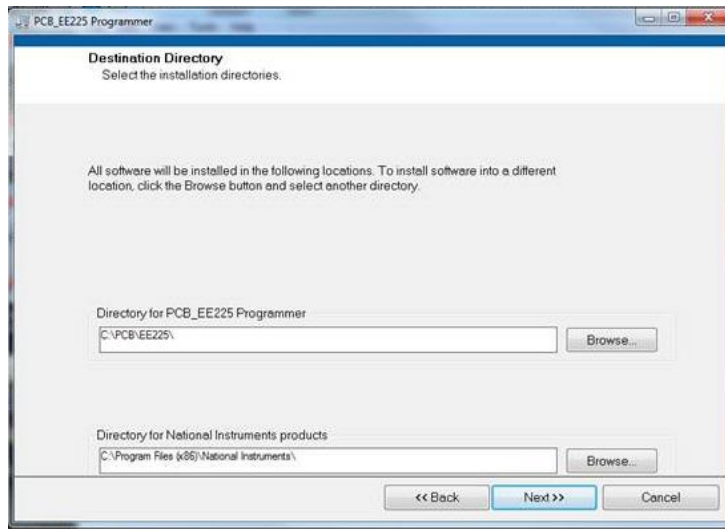

**Figure 11 – Install Location Screen**

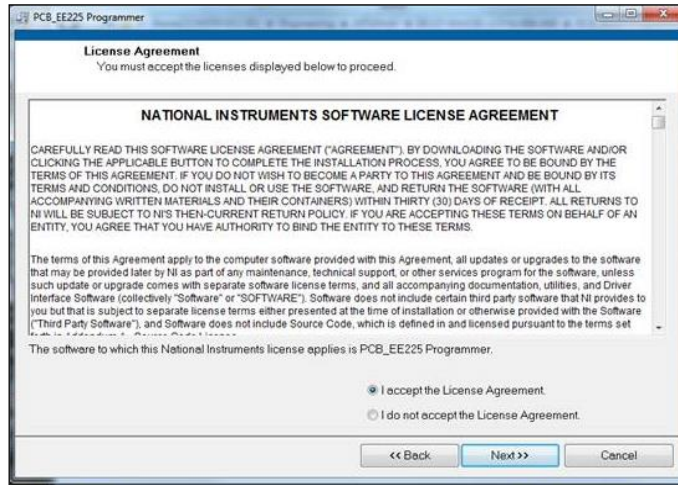

Figure 12 – National Instruments Software License Agreement

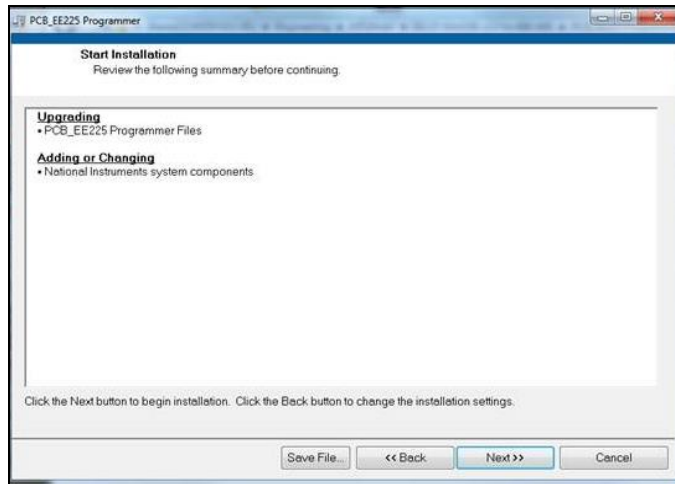

Figure 13 – Installation Verification Screen

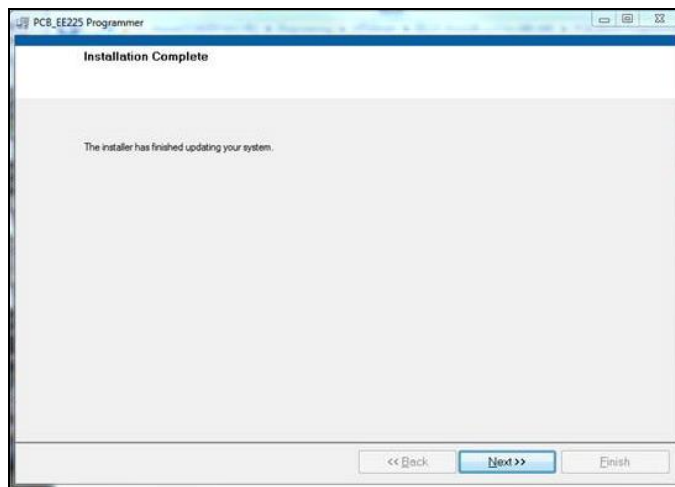

Figure 14 – Installation Complete Screen

After the software completes, the USB driver installer will start automatically. The initial USB installer will look similar to the one below.



Figure 15 – WinUSB Driver Installation Screen

The drivers will now be properly installed and you should get the following screen. Click “Finish”. The software is now ready to use.



Figure 16 – WinUSB Driver Installation Complete Screen

### Running the Software

Connect the USB programmer cable to a USB port on the PC and then run the software from the Start | All Programs | PCB EE225 Software menu item.

Initially the screen will appear as in **Error! Reference source not found.** with a yellow bar and status indicating 'Initializing...' followed by the message: "Connecting to USB Dongle..."

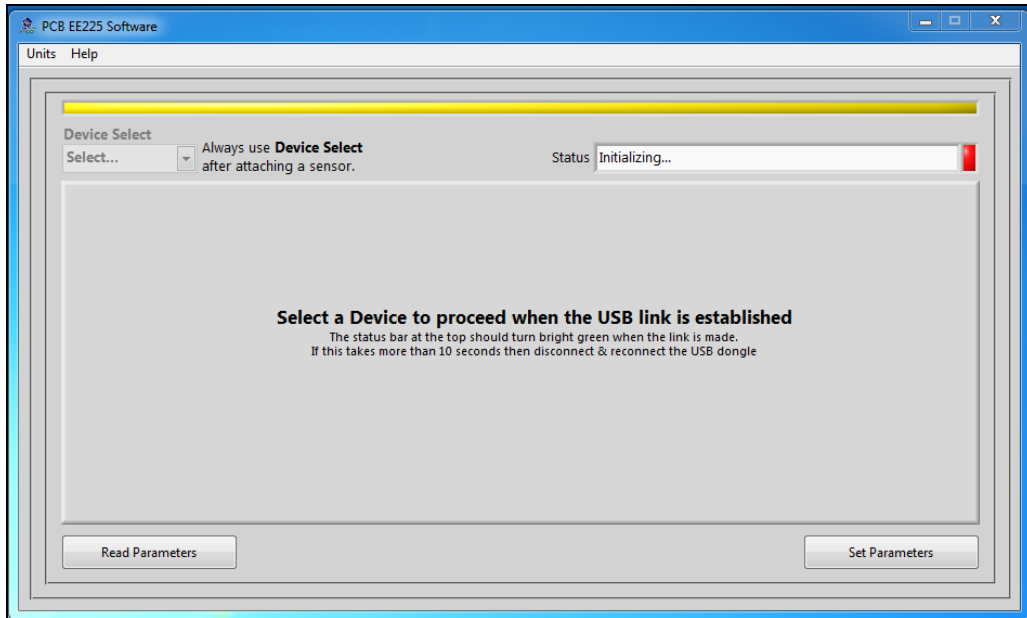

Figure 17 – Software While Connecting to USB Programmer Cable

Once the connection is made the bar at the top of the screen will turn green and the status will indicate "USB Connection Success - Select a device". If the software and USB programmer cable fail to connect, remove and reinsert the USB programmer cable.

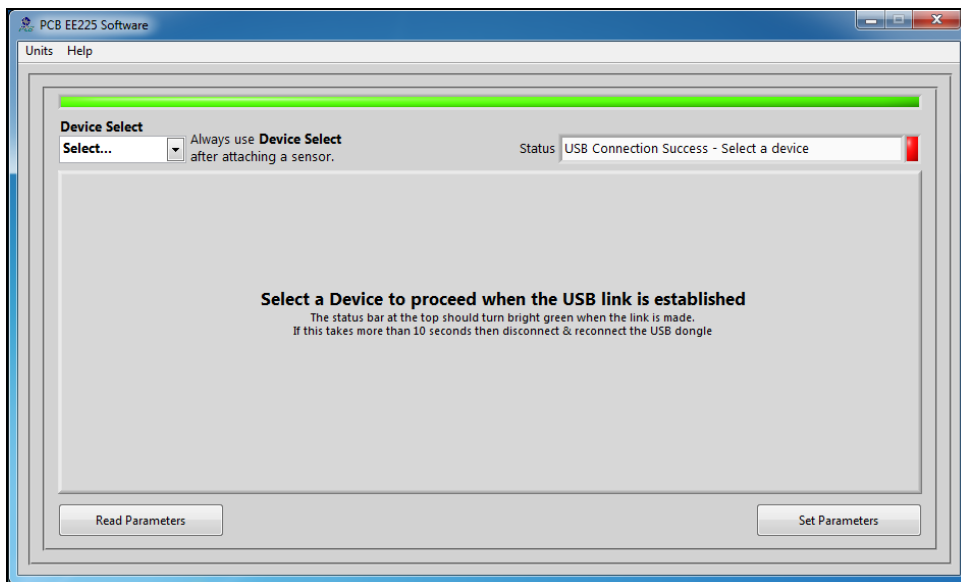
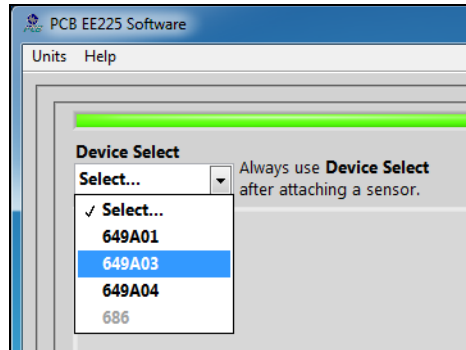

Figure 18 – Software After Connecting to USB Programmer Cable

To select a device, click on the Device Select pull down menu and select the device you'd like to program. In this case, select 649A03.



**Figure 19 – Device Selection**

Once a product is selected, the software will prompt you to confirm connection of the sensor to the PC using the USB programmer cable. Click OK to proceed.

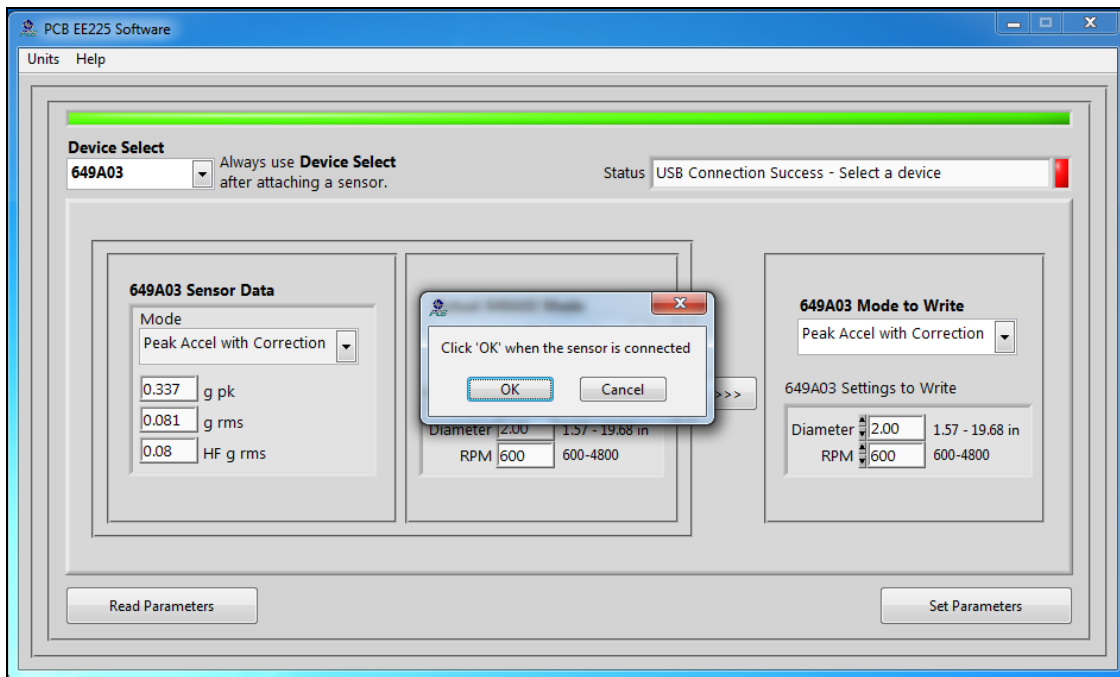

**Figure 20 – Sensor Connection Screen**

While the software is establishing communication with the sensor, the status will display 'Checking Status...' and the colored indicator box next to the status will alternate between red and yellow. This will take approximately 15 seconds. Once communication is established, the indicator box will turn green and the software will read the sensors current settings and data. The fields presented in the main body of the screen will be specific to the selected sensor.

### Programming Sections

The screen has three sections:

- 649A03 Sensor Data – This section displays the current vibration data in g's peak, g's RMS and HF g's RMS (g's RMS with 2.5 kHz high-pass filter applied)
- Actual 649A03 Settings – This section shows the settings currently programmed in the sensor.
- 649A03 Settings to Write – This section shows the options for programming the sensor.

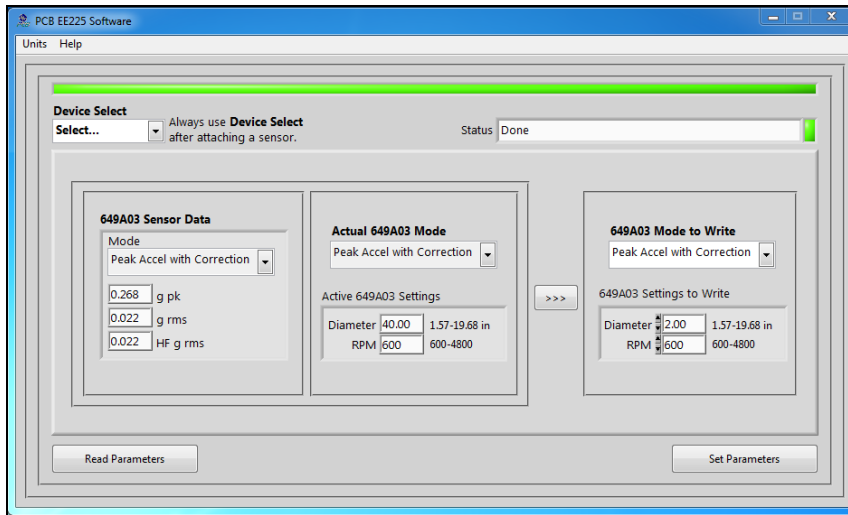

Figure 21 – Typical Screen After Successful Parameter Read

### Reading and Writing Parameters

- Reading Parameters - To read the current sensor settings, click the Read Parameters button. This operation takes approximately 45 seconds to complete.
- Transferring Actual Settings to Settings to Write Field - Use the '>>>' button to transfer all Actual Settings to the Settings to Write fields.
- Writing Parameters- Select the appropriate mode and enter any pertinent parameter information. Click the Set Parameters button. This causes the settings to be sent to the sensor and then read back and displayed in the Actual 649A03 mode.

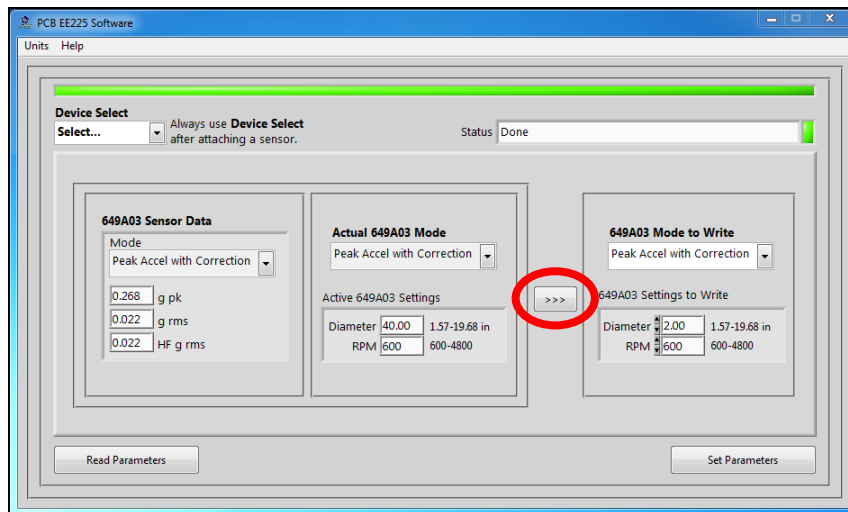

Figure 22 – Transferring Actual Settings to Settings to Write Field

### Parameter Options

There are several parameters that can be programmed to optimize performance of the Bearing Fault Detector Plus. At any point during the programming process, the values can be changed between imperial and metric measurements by clicking the Units dropdown in the top navigation menu and then selecting the appropriate measurement type.

Machinery Type	Output Signal	Programmable Parameter(s)	Range for Programmable Parameter(s)
Constant Speed	Peak Acceleration	Full scale measurement range	2-50 g 19.61-490.33 m/s <sup>2</sup>
	RMS Acceleration	Full scale measurement range	2-50 g 19.61-490.33 m/s <sup>2</sup>
	Peak Acceleration with Correction	Bearing diameter	1.57-19.98 in 40-500 mm
Rotation speed		600-4,800 RPM	
Variable Speed	Crest Factor	N/A	N/A
	Crest Factor Plus	N/A	N/A

Unless otherwise specified, the sensor comes from the factory with a default setting of peak acceleration output with a full scale of 8g peak.

*Portable 4-20 mA Loop Calibrator*

The loop calibrator (Model 699A05) provides 24V loop power and displays the transmitters electrical current output. This can be used with the sensor for measuring baseline values. Visit [www.pcb.com](http://www.pcb.com) for more information on the loop calibrator.



Figure 23 – Loop Calibrator



## Cable Ordering Information

Listed below are some of the more popular cables for use with BFD+. For additional information on cable options, visit [www.pcb.com](http://www.pcb.com) and click on the "Cables & Connectors" tab or call IMI for assistance.

IMI Part Number: 052 BR 010 BZ

### Cable Model Series

- 052 Polyurethane, Shielded, Twisted Pair
- 048 Armored Polyurethane, Shielded, Twisted Pair

### Switch Connector Type

- AE 2 socket MIL type with environmental boot
- BP 2 socket MIL type high temp with strain relief
- BR 2 socket MIL type molded composite
- BQ 2 socket MIL type molded composite, right angle

### Cable Length

- 010 10 feet
- 020 20 feet
- 030 30 feet
- 040 40 feet
- 050 50 feet
- XXX Any length

### Cable termination

- BZ Blunt Cut



**Warning 1 – ESD sensitivity**

---

**The power supply/signal conditioner should not be opened by anyone other than qualified service personnel.** This product is intended for use by qualified personnel who recognize shock hazards and are familiar with the safety precautions required to avoid injury.

**Warning 2 – ESD sensitivity**

---

This equipment is designed with user safety in mind; however, the protection provided by the equipment may be impaired if the equipment is used in a manner not specified by PCB Piezotronics, Inc.

**Caution 1 – ESD sensitivity**

---

**Cables can kill your equipment.** High voltage electrostatic discharge (ESD) can damage electrical devices. Similar to a capacitor, a cable can hold a charge caused by triboelectric transfer, such as that which occurs in the following:

- *Laying on and moving across a rug,*
- *Any movement through air,*
- *The action of rolling out a cable, and/or*
- *Contact with a non-grounded person.*

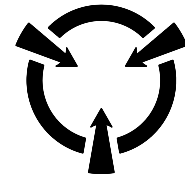

**CAUTION**  
ELECTROSTATIC  
DISCHARGE SENSITIVE

**The PCB solution for product safety:**

- *Connect the cables only with the AC power off.*
- *Temporarily “short” the end of the cable before attaching it to any signal input or output.*

**Caution 2 – ESD sensitivity**

---

**ESD considerations should be made prior to performing any internal adjustments on the equipment.** Any piece of electronic equipment is vulnerable to ESD when opened for adjustments. Internal adjustments should therefore be done ONLY at an ESD-safe work area. Many products have ESD protection, but the level of protection may be exceeded by extremely high voltage.

### **Warranty**

---

IMI instrumentation is warranted against defective material and workmanship for 1 year unless otherwise expressly specified. Damage to instruments caused by incorrect power or misapplication, is not covered by warranty. *If there are any questions regarding power, intended application, or general usage, please consult with your local sales contact or distributor.* Batteries and other expendable hardware items are not covered by warranty.

### **Service**

---

Because of the sophisticated nature of IMI instrumentation, field repair is typically **NOT** recommended and may void any warranty. If factory service is required, return the instrumentation according to the "Return Procedure" stated below. *A repair and/or replacement quotation will be provided prior to servicing at no charge.* Before returning the unit, please consult a factory IMI applications engineer concerning the situation as certain problems can often be corrected with simple on-site procedures.

### **Return procedure**

---

*To expedite returned instrumentation, contact a factory IMI applications engineer for a RETURN MATERIAL AUTHORIZATION (RMA) NUMBER.* Please have information available such as model and serial number. Also, to insure efficient service, *provide a written description of the symptoms and problems with the equipment to a local sales representative or distributor, or contact IMI if none are located in your area.*

Customers outside the U.S. should consult their local IMI distributor for information on returning equipment. For exceptions, please contact the International Sales department at IMI to request shipping instructions and an RMA. For assistance, please call (716) 684-0003, or fax us at (716) 684-3823. You may also receive assistance via e-mail at [imi@pcb.com](mailto:imi@pcb.com) or visit our web site at [www.pcb.com](http://www.pcb.com).

### **Customer Service**

---

IMI, a division of PCB Piezotronics, guarantees **Total Customer Satisfaction**. If, at any time, for any reason, you are not completely satisfied with any IMI product, IMI will repair, replace, or exchange it at no charge. You may also choose to have your purchase price refunded.

IMI offers to all customers, at no charge, 24-hour phone support. This service makes product or application support available to our customers, day or night, seven days a week. When unforeseen problems or emergency situations arise, call the **IMI Hot Line at (716) 684-0003**, and an application specialist will assist you.

<b>Performance</b>	<u>ENGLISH</u>	<u>SI</u>	
Output(Loop power)	4-20 mA	4-20 mA	
Sampling Time	1 sec	1 sec	
Measurement Range(HPF 250 Hz)	0-2 to 0-50 g pk	0-2 to 0-50 g pk	[1][2]
Measurement Range(HPF 2500 Hz)	0-2 to 0-50 RMS	0-2 to 0-50 RMS	[1][2]
Compensated Peak(HPF 250 Hz)	1 to 16	1 to 16	
Crest Factor(HPF 250 Hz)	1 to 16	1 to 16	[1]
Crest Factor Plus(HPF 250 Hz)	1 to 16	1 to 16	[1]
Bearing Diameter	1.57 to 19.69 in	40 to 500 mm	
Bearing Rotation Speed	600 to 4800 RPM	10 to 80 Hz	
Linearity(Loop powered)	10 %	10 %	
<b>Environmental</b>			
Temperature Range	-40 to 212 °F	-40 to 100 °C	
Storage Temperature Range	-40 to 257 °F	-40 to 125 °C	
<b>Electrical</b>			
Excitation Voltage	15 to 30 VDC	15 to 30 VDC	
Load Resistance	50(Vs-15) Ohm	50(Vs-15) Ohm	
Electrical Isolation	>10^8 Ohm	>10^8 Ohm	
<b>Physical</b>			
Size (Height x Hex)	2.60 in x 1.25 in	66 mm x 32 mm	
Weight	5.7 oz	162 gm	[3]
Mounting Thread	1/4 - 28 UNF	1/4 - 28 UNF	
Mounting Torque	3 to 5 ft-lb	4 to 7 Nm	
Sensing Element	Piezoelectric Accelerometer	Piezoelectric Accelerometer	
Housing Material	Stainless Steel	Stainless Steel	
Sealing	Welded Hermetic	Welded Hermetic	
Electrical Connector	2-Pin MIL-C-5015	2-Pin MIL-C-5015	
Electrical Connection Position	Top	Top	
Electrical Connections(Pin A)	4-20 mA Pos (+)	4-20 mA Pos (+)	
Electrical Connections(Pin B)	4-20 mA Neg (-)	4-20 mA Neg (-)	
Overload Limit (Shock)	5000 g pk	49,050 m/s <sup>2</sup> pk	

**OPTIONAL VERSIONS**

Optional versions have identical specifications and accessories as listed for the standard model except where noted below. More than one option may be used.

**CS** - Canadian Standards Association Approved Intrinsically Safe

**M** - Metric Mount  
Supplied Accessory : Model M081A61 Mounting Stud 1/4-28 to M6 X 1 (1)

**NOTES:**

[1] Customer programmable parameters  
 [2] With 0.1g Step  
 [3] Typical.  
 [4] See PCB Declaration of Conformance PS124 for details.

**SUPPLIED ACCESSORIES:**  
 Model 081A41 Mounting stud 1/4-28 socket head set screw brass tip stainless steel 5/8" long (1)

Entered: LK	Engineer: NJF	Sales: MC	Approved: NJF	Spec Number:
Date: 9/12/2016	Date: 9/12/2016	Date: 9/12/2016	Date: 9/12/2016	<b>45609</b>



**IMI SENSORS**  
A PCB PIEZOTRONICS DIV.  
3425 Walden Avenue, Depew, NY 14043

**Phone: 800-959-4464**  
**Fax: 716-684-3823**  
**E-Mail: imi@pcb.com**



*All specifications are at room temperature unless otherwise specified.  
 In the interest of constant product improvement, we reserve the right to change specifications without notice.*

ICP® is a registered trademark of PCB Group, Inc.

2

1

PCB Piezotronics Inc. claims proprietary rights in the information disclosed hereon. Neither it nor any reproduction thereof will be disclosed to others without the written consent of PCB Piezotronics Inc.

REVISIONS

REV	DESCRIPTION	DIN
C	ADDED RELATED BLOCK	43847

45610

RELATED DRAWING

NO MODIFICATIONS PERMITTED WITHOUT THE APPROVAL OF THE AUTHORIZED PERSON

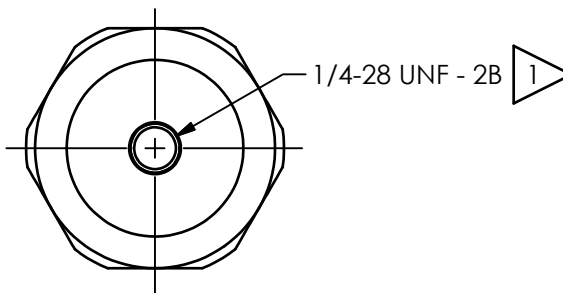
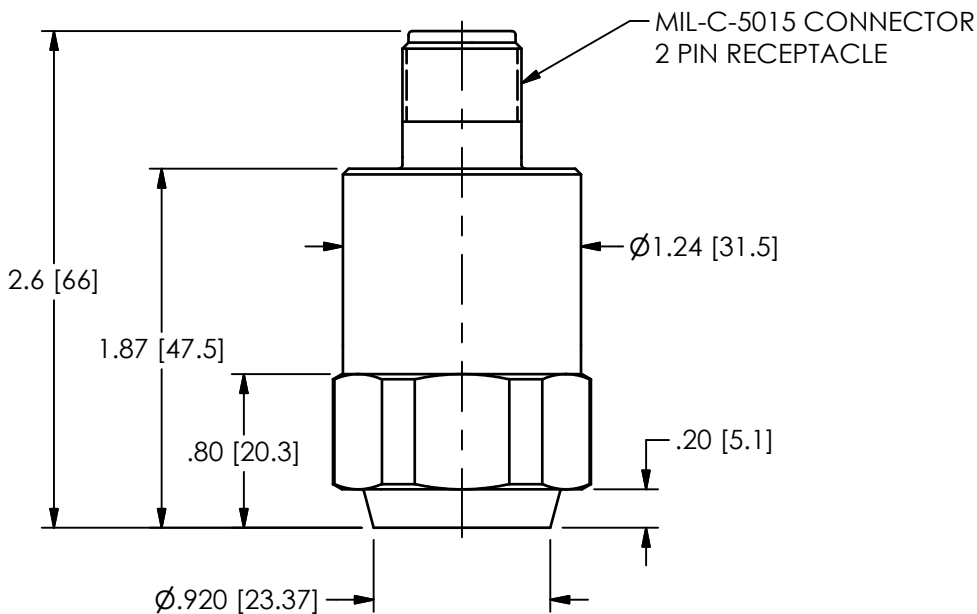
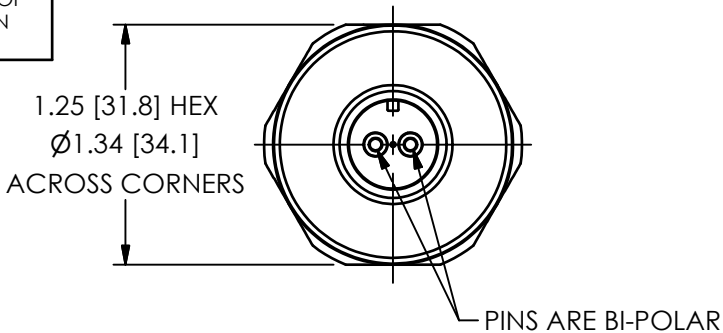

1 MODEL 081A40 MOUNTING STUD SUPPLIED AS STANDARD. FOR M PREFIXES (M649A03)  
MODEL M081A61 (M6 X 1.0 TO 1/4"-28) MOUNTING STUD REPLACES 081A40.

UNLESS OTHERWISE SPECIFIED TOLERANCES ARE:		DRAWN		CHECKED		ENGINEER			
DIMENSIONS IN INCHES	DIMENSIONS IN MILLIMETERS [ IN BRACKETS ]	BB	10/15/15	ECB	10/15/15	GGG	10/15/15		
DECIMALS XX ±.03 XXX ±.010	DECIMALS X ± 0.8 XX ± 0.25	TITLE OUTLINE DRAWING MODEL (CS)649A03 BEARING FAULT DETECTOR PLUS						<b>PCB PIEZOTRONICS™</b>	
ANGLES ± 2 DEGREES	ANGLES ± 2 DEGREES							3425 WALDEN AVE. DEPEW, NY 14043 (716) 684-0001 E-MAIL: sales@pcb.com	
FILLETS AND RADII .003 - .005	FILLETS AND RADII 0.07 - 0.13					CODE IDENT. NO. 52681	DWG. NO. 45610		
						SCALE: FULL	SHEET 1 OF 1		

2

1